

EWCM 436D PRO / A - CRII

CRII series compressor rack controllers

07/2016



**USER
GUIDE**

The information given in this document contains general descriptions and/or technical characteristics concerning the performance of the products contained. This document is not intended to replace and must not be used to determine the suitability and reliability of these products for any users' specific applications. Each user or integrator is responsible for performing the risk analysis, evaluation and appropriate and complete testing of the products according to the specific application or use in question. Eliwell and its sister companies or subsidiaries shall not be legally or economically liable for any incorrect use of the information contained in this documentation.

If you have any suggestions for improvement or modification, or find any errors in this publication, please contact us.

This document may not be reproduced wholly or partly in any form and using any electronic or mechanical means, including photocopies, without the express written authorisation of Eliwell.

The installation and use of this product must comply with all applicable state, regional and local safety regulations. For safety reasons and to ensure greater compliance with the data of the documented system, component repairs must be performed exclusively by the manufacturer.

When using devices for applications with technical safety requirements, comply with the relevant instructions.

Failure to use Eliwell software or other software approved by Eliwell with our hardware products can result in injury, damage or incorrect operating results.

Failure to comply with this information can result in injury or damage to the equipment.

© 2016 Eliwell Controls s.r.l. All rights reserved

CONTENTS



CHAPTER 1.	Introduction	11
	1.1. General description	11
	1.1.1. Technical Specifications	12
	1.1.2. Main Functions	12
CHAPTER 2.	Mechanical installation.....	13
	2.1. Before starting.....	13
	2.2. Disconnection from the power supply	13
	2.3. Comments concerning programming	14
	2.4. Operating environment.....	14
	2.5. Comments concerning installation	14
	2.6. SKP 10 installation	15
	2.7. Installing the EWCM 436D PRO	16
CHAPTER 3.	Electrical connections.....	19
	3.1. Best wiring practices	19
	3.1.1. Wiring guidelines	19
	3.1.2. Rules for screw-type terminal boards.....	20
	3.1.3. Protecting the outputs from damage from inductive loads	21
	3.1.4. Specific considerations for handling.....	23
	3.1.5. Analogue inputs-probes.....	23
	3.1.6. Serial connections	24
	3.2. Wiring diagrams	25
	3.2.1. EWCM 436D PRO A / CR11	25
	3.2.2. Example of low voltage/low current input/output connection.....	27
	3.2.3. Standard configuration with high voltage outputs.....	29
	3.2.4. Standard configuration of digital/analogue inputs	30
	3.3. Example of SKP 10 connection.....	30
	3.3.1. SKP 10	30
CHAPTER 4.	Technical data	31
	4.1. General Specifications	32
	4.1.1. Controller Modules	32

4.2. I/O features	33
4.2.1. Controller Modules	33
4.3. Serial ports	34
4.3.1. Power supply:.....	34
4.4. Mechanical technical specifications	35
4.5. Dimensions	36
CHAPTER 5. User Interface (folder PAR/UI).....	37
5.1. Keys	37
5.1.1. Description of keys – combined action.....	37
5.2. LEDs and Display.....	38
5.2.1. Display.....	38
5.2.2. LED	38
5.3. First switch-on	39
5.4. Access to folders - Menu structure.....	39
5.5. BIOS menu.....	39
5.5.1. BIOS “States” menu	39
5.5.2. BIOS programming menu.....	43
5.5.3. Functions (folder Par/FnC).....	44
5.6. A/CRII application menu.....	45
5.6.1. A/CRII states menu	45
5.6.2. A/CRII Programming menu	47
CHAPTER 6. Physical I/O configuration (folder PAR/CL...CR).....	48
6.1. Analogue inputs.....	48
6.2. Digital inputs.....	49
6.3. Digital outputs	49
6.4. Analogue outputs	49
CHAPTER 7. Device configuration (folder PAR/CnF...LEd)	51
7.1. Device configuration parameters	51
7.1.1. Type of refrigerant	51
7.1.2. Number of compressors - ON/OFF	52
7.1.3. Number of CRII compressor solenoid valves	52
7.1.4. Managing the digital and analogue fans.....	52
7.1.5. Temperature probe enabling	52

	7.2. I/O configuration parameters.....	53
	7.2.1. Configuration of analogue inputs.....	53
	7.2.2. Configuration of analogue outputs	53
	7.2.3. Configuration of digital inputs.....	54
	7.2.4. Digital output configuration.....	54
	7.2.5. LED configuration.....	54
CHAPTER	8. Compressors.....	55
	8.1. Type of compressors supported	55
	8.2. System configurations supported	55
	8.3. Overview of compressor control.....	55
	8.3.1. CRII compressor on mode	56
	8.3.2. Modulation of CRII valves and safety times	57
	8.3.3. Single compressor switch-on mode	59
	8.3.4. Switching off single compressors	59
	8.3.5. Switching off the CRII compressor	60
CHAPTER	9. Fans (FAn)	61
	9.1. Managing the condensation pressure	61
	9.1.1. Type of condensation supported	61
	9.1.2. Supported system configurations	61
	9.1.3. Digital fans.....	61
	9.1.4. Analogue fan	62
	9.2. Floating condensation	62
	9.2.1. Operating conditions	62
	9.2.2. Subcooling.....	63
CHAPTER	10. Parameters (PAR).....	64
	10.1. Parameters / visibility table, folder visibility table and client table ...	65
	10.1.1. BIOS parameters / visibility table	66
	10.1.2. Folder visibility table	69
	10.1.3. Application parameters table	70
	10.1.4. Client Table.....	77
CHAPTER	11. Alarms.....	80
	11.1. Alarm log.....	81

CHAPTER 12. Updating the device	82
12.1. Direct connection with Device Manager	82
12.2. Connecting to UNICARD / MFK 100	83
12.3. Firmware updating	83
CHAPTER 13. Monitoring	84
13.1. Configuration with Modbus RTU	84
13.1.1. Data format (RTU)	84
13.1.2. Modbus commands available and data areas	85
13.2. Configuration of device address	85
13.2.1. Configuration of parameter addresses	85
13.2.2. Configuration of variable addresses / states	85

INFORMATION ABOUT THE MANUAL



Document scope

This document describes the **EWCM 436D PRO** controllers and relative accessories, including information on installation and wiring.

Use this document to:

- Install and use your **EWCM 436D PRO** controller.
- Connect the **EWCM 436D PRO** controller to a programming device equipped with **Device Manager** software.
- Become familiar with the functions of the **EWCM 436D PRO** controller.

NOTE: Read this document and all related documents carefully before installing, operating or maintaining the controller.

Note regarding validity

This document is valid for **Device Manager**.

Related documents

Document title	Reference document code
Instruction sheet EWCM 436D PRO / A - CR11	9IS54502

You can download these technical publications and other technical information from our website at:

www.eliwell.com

SAFETY INFORMATION



Important information

Read these instructions carefully and visually inspect the equipment to familiarise yourself with the device before attempting to install it, put it into operation or service it. The following warning messages may appear anywhere in this documentation or on the equipment to warn of potential dangers or to call attention to information that can clarify or simplify a procedure.



The addition of this symbol to a danger warning label indicates the existence of an electrical danger that could result in personal injury should the user fail to follow the instructions.



This is the safety warning symbol. It is used to warn the user of the potential dangers of personal injury. Observe all the safety warnings accompanied by this symbol to avoid the risk of serious injury or death.

DANGER

DANGER indicates a dangerous situation which, if not prevented, **may cause** serious injury or death.

WARNING

WARNING indicates a potentially dangerous situation which, if not avoided, **could result in** death or serious injury.

CAUTION

CAUTION indicates a potentially dangerous situation which, if not avoided, **can result in minor** or moderate injury.

NOTICE

NOTICE used in reference to procedures not connected to physical injuries.

NB

Electrical equipment must be installed, used and repaired by qualified personnel only.

Eliwell accepts no responsibility for any consequences resulting from the use of this material.

A qualified person is someone who has specific skills and knowledge regarding the structure and the operation of electrical equipment and who has received safety training on how to avoid the inherent dangers.

Permitted use

This product is intended for controlling CRII compressor racks.

For safety reasons, the device must be installed and used in accordance with the instructions provided. In particular, parts carrying dangerous voltages must not be accessible under normal conditions.

The device must be adequately protected from water and dust with regard to the application, and must only be accessible using tools (with the exception of the front panel).

The device is also suitable for use in commercial and household refrigeration appliances and/or similar equipment and has been tested for safety aspects in accordance with the harmonized European reference standards.

Prohibited use

Any use other than that described in the previous paragraph, Permitted Use, is strictly forbidden.

The relay contacts supplied are electromagnetic and are subject to wear. The protection devices required by international or local laws must be installed outside the instrument.

Liability and residual risks

The liability of Eliwell is limited to the correct and professional use of the product according to the directives referred to herein and in the other supporting documents, and does not cover any damage (including but not limited to) the following causes:

- unspecified installation/use and, in particular, in contravention of the safety requirements of established legislation or specified in this document
- use on equipment which does not provide adequate protection against electrocution, water and dust in the actual installation conditions;
- use on equipment in which dangerous components can be accessed without the use of specific tools;
- installation/use on equipment which does not comply with established legislation and technical standards.

Disposal



The equipment (or product) must be subjected to separate waste collection in compliance with the local legislation on waste disposal.

Product related information

DANGER

RISK OF ELECTRIC SHOCK, EXPLOSION OR ELECTRIC ARC

- Turn off all devices, including connected devices, before removing any covers or doors, or installing/uninstalling accessories, hardware, cables, or wires.
- To check that the system is powered down, always use a voltmeter properly calibrated to the nominal voltage value.
- Before restarting the unit, replace and secure all covers, hardware accessories, cables, and check for a good ground connection.
- Use this equipment and all connected products only at the specified voltage.

Failure to follow these instructions will result in death or serious injury.

This device is designed to operate outside of any dangerous location.
Install this device only in areas known to be free from dangerous atmospheres.

DANGER

RISK OF EXPLOSION

Install and use this device only in places where there is no risk.

Failure to follow these instructions will result in death or serious injury.

WARNING

LOSS OF CONTROL

- The control system designer must consider the potential failure modes of the control circuit and, for some critical control functions, provide a means for reaching a safe condition during and after a circuit failure. Examples of critical control functions are the emergency stop and end of travel stop, power supply cut-off and restart.
- Separate or redundant control circuits must be provided for critical control functions.
- The system control circuits can include communication connections. Keep in mind the implications of transmission delays or sudden connection failures.
- Comply with all the standards regarding accident protection and the local applicable safety directives.⁽¹⁾
- Every implementation of this device must be tested individually and completely in order to check its proper operation before putting it in service.

Failure to follow these instructions can result in death, serious injury, or equipment damage.

(1) For additional information, refer to the standards NEMA ICS 1.1 (latest edition), "Safety Guidelines for the Application, Installation, and Maintenance of Solid State Control" and NEMA ICS 7.1 (latest edition) "Safety Standards for Construction and Guide for Selection, Installation and Operation of Adjustable-Speed Drive Systems" or to equivalent standards that regulate your particular location.

WARNING

INCORRECT OPERATION OF THE DEVICE

- Only use software approved by Eliwell when using this device.
- Update your application program each time the physical hardware configuration changes.

Failure to follow these instructions can result in death, serious injury, or equipment damage.

CHAPTER 1

Introduction

1.1. General description

The **EWCM 436D PRO** controller is the compact parametric controller solution in the **Eliwell** platform for managing CR11 series compressor racks.

NOTE: In this manual the photos are purely indicative, in order to show the **EWCM 436D PRO**.
The dimensions shown in the figures are not to scale.

The **EWCM 436D PRO** range includes:

- **Controller**
- **Remote display**

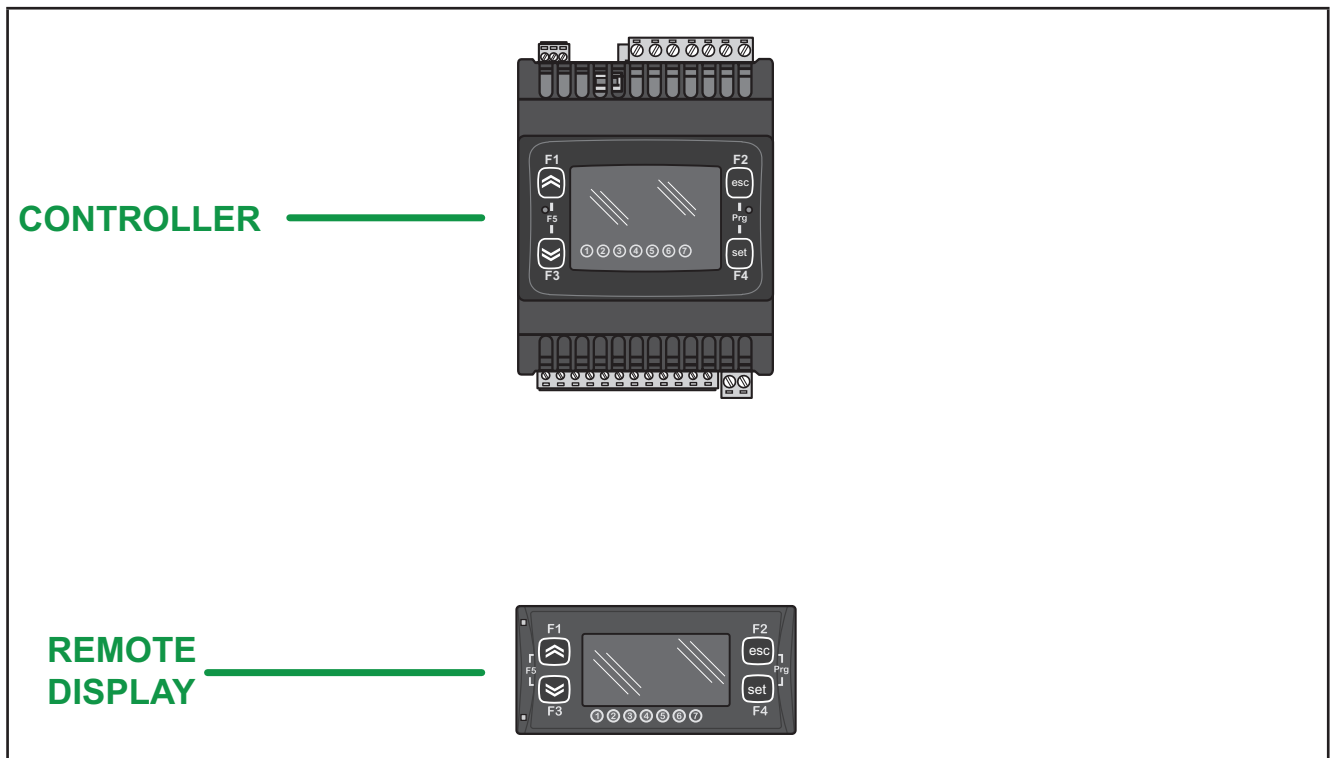

Fig. 1. EWCM 436D PRO & SKP 10

The **EWCM 436D PRO controller** can be used to download parameter maps via the **MFK 100 / UNICARD**.

In association with the hardware, it is possible to download the **Device Manager** software, which allows users to change the hardware configuration according to need.

Ratiometric pressure sensors, external modules (e.g. fan modules) and displays can also be connected with no need for any further serial interfaces.

The **SKP 10 display** faithfully replicates what is displayed on the controller and further facilitates all configuration operations.

1.1.1. Technical Specifications



EWCM 436D PRO is available with 6 digital inputs, 3 relay outputs, 2 TRIAC outputs, 1 analogue output PWM, 2 low voltage analogue outputs (SELV) 0...10 V, 1 low voltage analogue output (SELV) 0 ... 10 V o 0... 20 mA/4...20 mA configurable, 2 digital Open Collector outputs for an external relay, 3 analogue inputs for NTC probes configurable also as digital inputs and 2 analogue inputs configurable also as digital, current or NTC inputs.

The 4DIN format guarantees maximum flexibility and easy installation.

Power supply 12-24 Vac

1.1.2. Main Functions

- Suction pressure control via a CRII compressor and up to max. 4 single compressors;
- Control up to 3 CRII valves;
- Discharge pressure control via digital fans or analogue output for inverter control;
- Floating condensation;
- Complete diagnostics, alarm log;
- Parameter settings via keyboard or PC;
- **MFK 100 / UNICARD** to upload and download parameter maps;
- NTC configurable analogue inputs NTC, 0...20 mA, 4...20 mA, 0...1 V, 0...5 V, 0...10 V or digital inputs configurable from parameters;
- RS-485 serial and Modbus RTU open supervision protocol;
- **Optional remote display** (cable up to 100 m) which may be connected up directly without a serial interface.

CHAPTER 2

Mechanical installation

2.1. Before starting

Before starting to install your system, read this chapter carefully. The use and application of information contained in this document requires experience in the design and programming of automated control systems. Only the user, the machine manufacturer or the system integrator can be familiar with all the process conditions and therefore only they are able to determine which automation equipment and relative safety devices and interlocks can be used in a correct and efficient manner. When the automation and control equipment and any other relative equipment or software are selected for a particular application, also the applicable local, regional and national standards and regulations must be taken into consideration. Caution must be used concerning compliance with all safety information, other electrical requirements or laws which may apply to your machine or process when using this device.

The use and application of information contained in this document requires experience in the design and programming of automated control systems. Only the user, the machine manufacturer or the system integrator can be familiar with all the conditions and factors present during installation and set up, preparing, starting-up and servicing the machine the process and therefore only they are able to determine which automation equipment and relative safety devices and interlocks can be used in a correct and efficient manner. When the automation and control equipment and any other relative equipment or software are selected for a particular application, also the applicable local, regional and national standards and regulations must be taken into consideration.

WARNING

REGULATORY INCOMPATIBILITY

Make sure that all equipment used and the systems designed comply with all applicable local, regional and national laws.

Failure to follow these instructions can result in death, serious injury, or equipment damage.

2.2. Disconnection from the power supply

All options and modules must be assembled and installed before installing the control system on an assembly rail, the panel door or other assembly surface. Before disassembling the equipment, remove the control systems from the assembly rail, plate or panel.

DANGER

RISK OF ELECTRIC SHOCK, EXPLOSION OR ELECTRIC ARC

- Turn off all devices, including connected devices, before removing any covers or doors, or installing/uninstalling accessories, hardware, cables, or wires.
- To check that the system is powered down, always use a voltmeter properly calibrated to the nominal voltage value.
- Before restarting the unit, replace and secure all covers, hardware accessories, cables, and check for a good ground connection.
- Use this equipment and all connected products only at the specified voltage.

Failure to follow these instructions will result in death or serious injury.

2.3. Comments concerning programming

The products described in this manual were designed and tested using Eliwell programming, configuration and maintenance software products.

⚠ WARNING

INCORRECT OPERATION OF THE DEVICE

- Only use software approved by Eliwell when using this device.
- Update your application program each time the physical hardware configuration changes.

Failure to follow these instructions can result in death, serious injury, or equipment damage.

2.4. Operating environment

This device is designed to operate outside of any dangerous location. Install this device only in areas known to be free from dangerous atmospheres.

⚠ DANGER

RISK OF EXPLOSION

Install and use this device only in places where there is no risk.

Failure to follow these instructions will result in death or serious injury.

⚠ WARNING

INCORRECT OPERATION OF THE DEVICE

Install and use the device in compliance with the conditions described in the general technical specifications.

Failure to follow these instructions can result in death, serious injury, or equipment damage.

2.5. Comments concerning installation

⚠ WARNING

INCORRECT OPERATION OF THE DEVICE

- If there is a risk of injury and/or damage to equipment, use the required safety interlocks.
- Install and use this device in a cabinet with a nominal voltage suited to the place of use.
- For power line and output circuit fuses and connections, comply with local and national regulations corresponding to the nominal current and voltage of the device being used.
- Do not use this equipment in critical safety conditions.
- Do not dismantle, repair or modify the equipment.
- Do not connect wires to the terminals not used and/or terminals marked with "No connection "(N.C.)".
- Do not install the devices in places subject to high humidity and/or dirt

Failure to follow these instructions can result in death, serious injury, or equipment damage.

NOTE: Fuses type JDYX2 or JDYX8 are UL recognised and CSA type-approved.

For mechanical sizes see [4.5. Dimensions on page 36](#).

EWCM 436D PRO controllers are designed for assembly on DIN rail.

When handling the equipment use caution to avoid damage caused by electrostatic discharge. In particular the unshielded connectors and in certain cases the open circuit boards are extremely vulnerable to electrostatic discharge.

⚠ WARNING

FAULTY OPERATION OF EQUIPMENT DUE TO ELECTROSTATIC DISCHARGE

- Keep the device in the protective packaging until ready for installation.
- The device must only be installed in type-approved casings and/or in points that prevent accidental access and provide protection from electrostatic discharge as defined in IEC 1000-4-2.
- When handling sensitive equipment, use an antistatic bracelet or equivalent earthed protective device against electrostatic discharge.
- Before handling the device, always discharge the static electricity from the body by touching an earthed surface or type-approved antistatic mat.

Failure to follow these instructions can result in death, serious injury, or equipment damage.

2.6. SKP 10 installation

The instrument is designed for panel assembly (refer to [Fig. 2 on page 15](#),

1. Make a 71x29 mm hole (2.80x1.14 in.).
2. Insert the instrument.
3. Fix it using the brackets supplied.

NOTE: The TTL serial is located on the left side of the device.

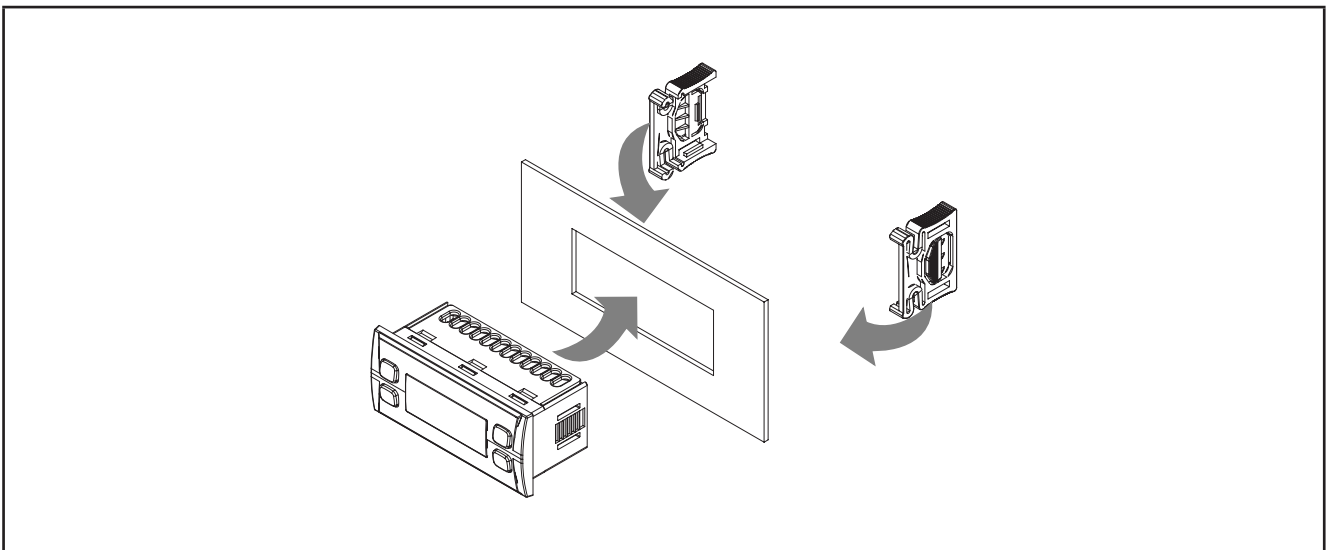

Fig. 2. Example of installation

2.7. Installing the EWCM 436D PRO

The instrument is designed for installation on a 4DIN rail (refer to [Fig. 3 on page 16](#), [Fig. 4 on page 16](#), [Fig. 5 on page 17](#) and [Fig. 6 on page 17](#)).

Follow the instructions below to install the BASE on DIN rail:

1. move the two spring docking devices to their standby position (use a screwdriver to press against the relative compartments);
2. Then install the instrument on the DIN rail,
3. pressing on the “spring docking devices” to put them into the locked position.

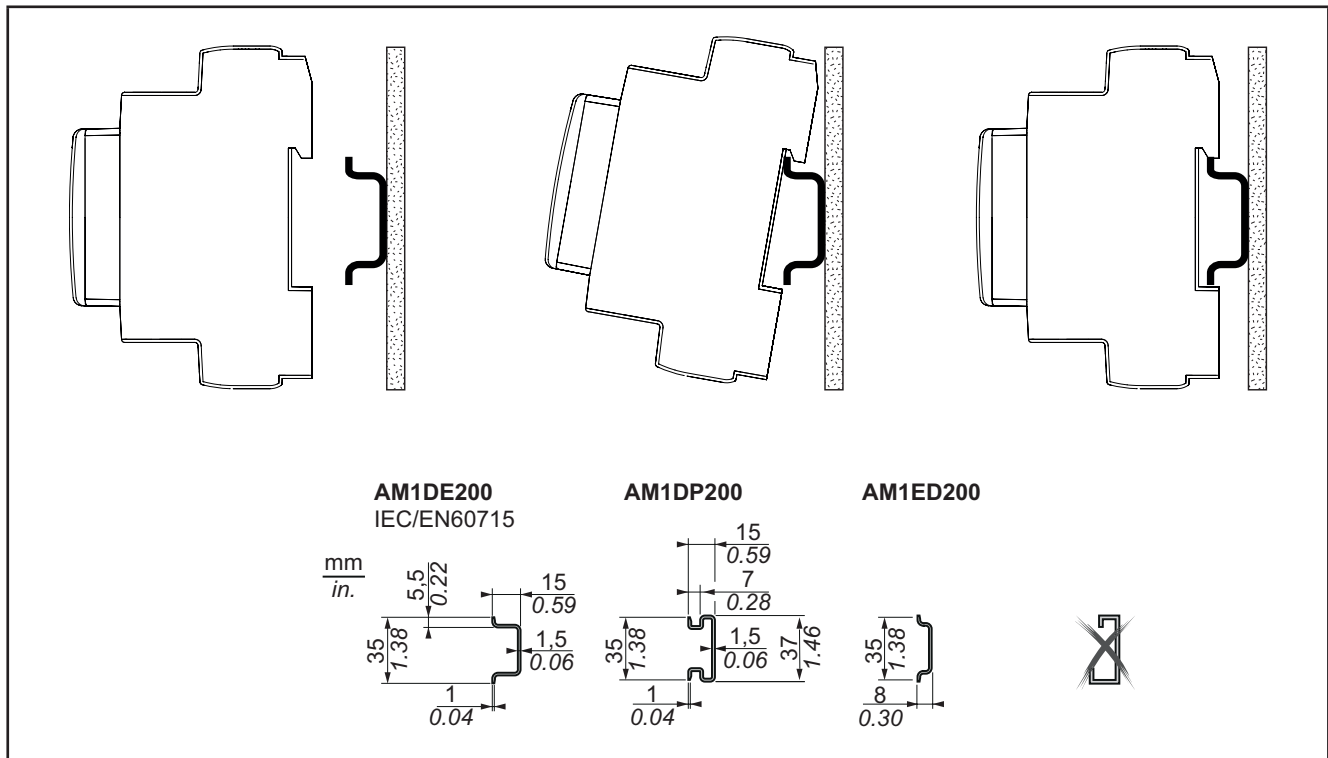

Fig. 3. DIN rail installation – side view

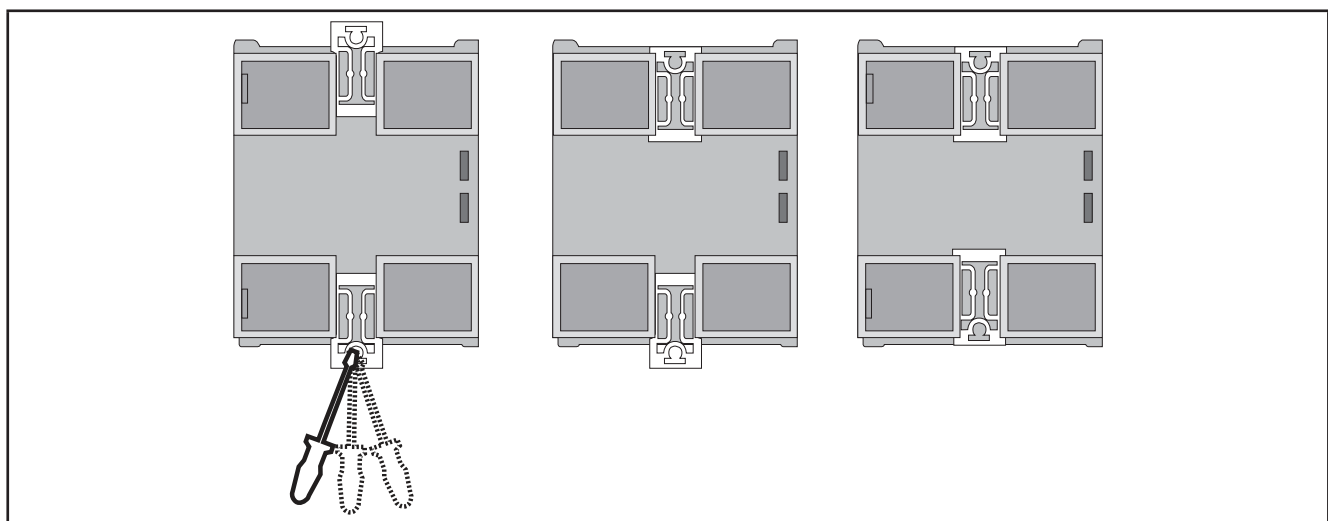

Fig. 4. DIN rail installation - rear view

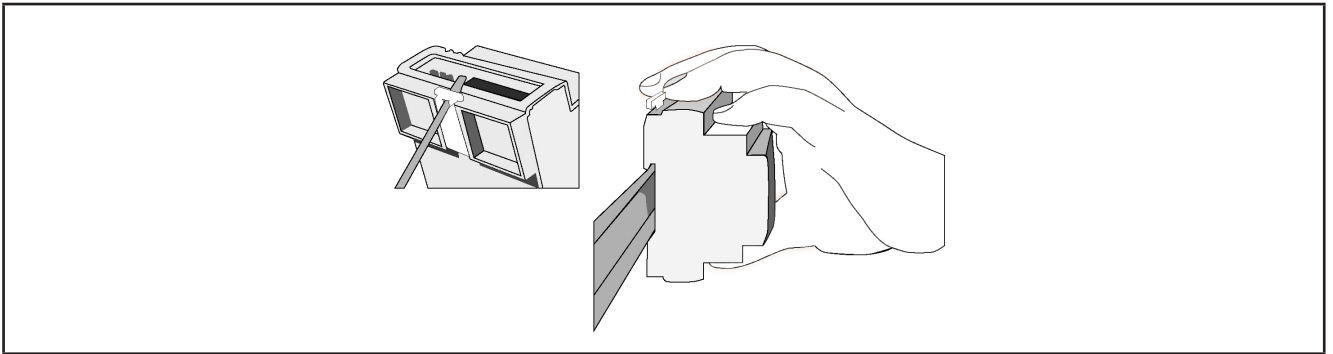

Fig. 5. DIN rail installation – ¾ view

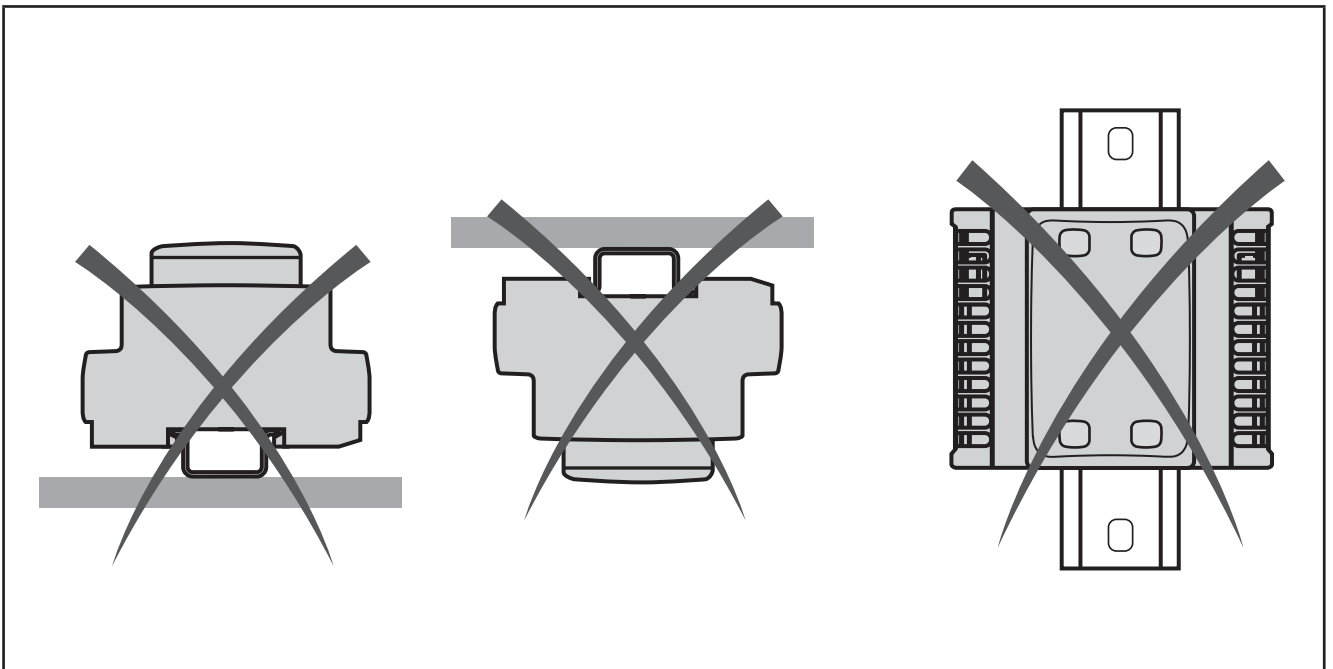

Fig. 6. Installation

The **EWCM 436D PRO** controller was designed as a class IP20 product and must be installed in a casing. Comply with the indicated distances when installing the product.

There are 3 types of distances:

- The **EWCM 436D PRO** controller and all sides of the cabinet (including the panel door).
- The terminal boards on the **EWCM 436D PRO** controller and the wiring raceways. These distances reduce the electromagnetic interference between the controller and the wiring raceways.
- The **EWCM 436D PRO** controller and the other heat-generating devices installed in the same cabinet.

⚠ WARNING

INCORRECT OPERATION OF THE DEVICE

- Place the devices dissipating the most heat in the top of the cabinet and ensure suitable ventilation.
- Do not place these devices near or above any devices which could cause overheating.
- Install the device in a point that guarantees the minimum distances from all structures and adjacent equipment as indicated in this document.
- Install all equipment in conformity with the technical specifications given in the respective documentation.

Failure to follow these instructions can result in death, serious injury, or equipment damage.

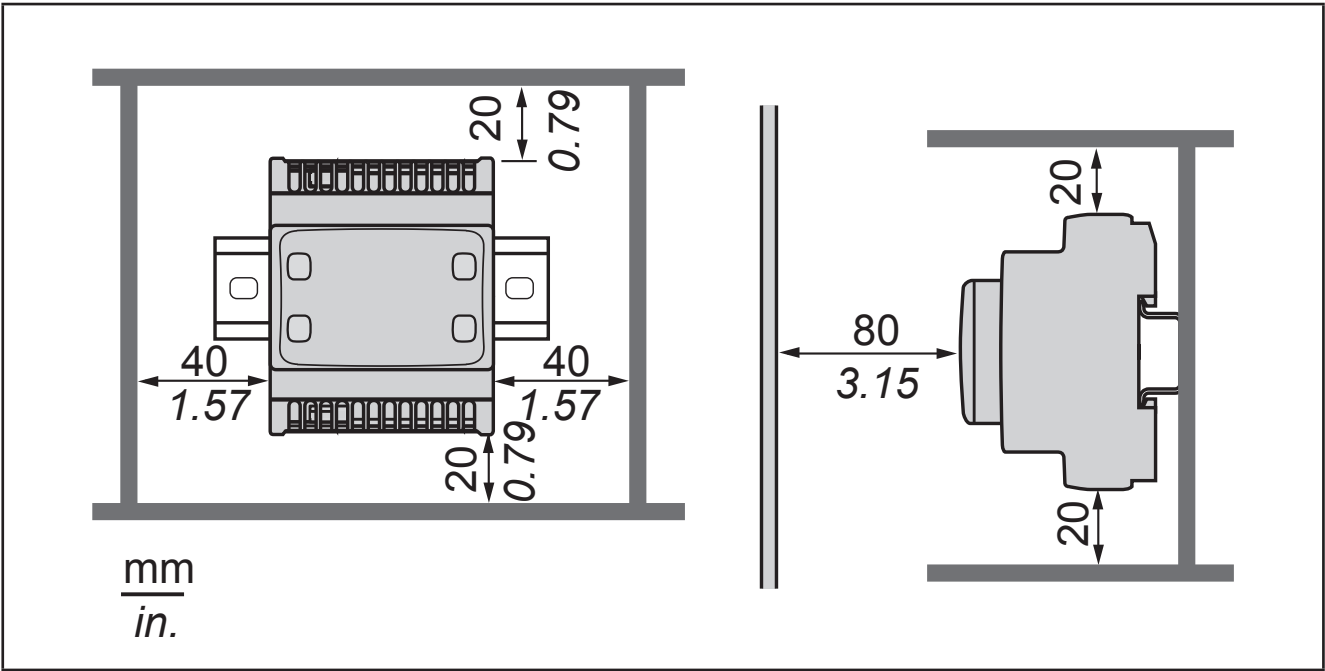

Fig. 7. Distances

CHAPTER 3

Electrical connections

3.1. Best wiring practices

The following information describes the guidelines for wiring and the best practices to follow when using the **EWCM 436D PRO** compressor rack controllers.

DANGER

RISK OF ELECTRIC SHOCK, EXPLOSION OR ELECTRIC ARC

- Turn off all devices, including connected devices, before removing any covers or doors, or installing/uninstalling accessories, hardware, cables, or wires.
- To check that the system is powered down, always use a voltmeter properly calibrated to the nominal voltage value.
- Before restarting the unit, replace and secure all covers, hardware accessories, cables, and check for a good ground connection.
- Use this equipment and all connected products only at the specified voltage.

Failure to follow these instructions will result in death or serious injury.

WARNING

LOSS OF CONTROL

- The control system designer must consider the potential failure modes of the control circuit and, for some critical control functions, provide a means for reaching a safe condition during and after a circuit failure. Examples of critical control functions are the emergency stop and end of travel stop, power supply cut-off and restart.
- Separate or redundant control circuits must be provided for critical control functions.
- The system control circuits can include communication connections. Keep in mind the implications of transmission delays or sudden connection failures.
- Comply with all the standards regarding accident protection and the local applicable safety directives.⁽¹⁾
- Every implementation of this device must be tested individually and completely in order to check its proper operation before putting it in service.

Failure to follow these instructions can result in death, serious injury, or equipment damage.

⁽¹⁾ For additional information, refer to the standards NEMA ICS 1.1 (latest edition), "Safety Guidelines for the Application, Installation, and Maintenance of Solid State Control" and NEMA ICS 7.1 (latest edition) "Safety Standards for Construction and Guide for Selection, Installation and Operation of Adjustable-Speed Drive Systems" or to equivalent standards that regulate your particular location.

3.1.1. Wiring guidelines

The controllers must be wired in compliance with the following rules:

- The I/O and communication wiring must be kept separate from the electrical wiring. These two types of wirings must be kept in separate raceways.
- Check that the operating conditions and environment comply with the specification values.
- Use wires of the correct diameter and suited to the voltage and current requirements.
- Use copper conductors (obligatory).
- Use twisted-pair shielded wires for analogue and/or high-speed I/Os.
- Use twisted-pair shielded wires for networks and field buses.

Use correctly earthed shielded wires for all analogue and high-speed inputs and outputs and communication connections. If shielded wires cannot be used for these connections, the electromagnetic interference may deteriorate the signal. Deteriorated signals can result in the controller, modules or attached equipment operating incorrectly.

⚠ WARNING

INCORRECT OPERATION OF THE DEVICE

- Use shielded wires for all high-speed I/O, analogue I/O and communication signals.
- Earth the wire shields for all analogue I/O, high-speed I/O and communication signals in a single point ⁽¹⁾.
- Lay the communication and I/O cables separately from the power cables.
- Reduce the length of the connections as far as possible and avoid winding them round electrically connected parts.







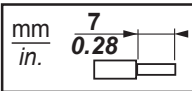

Failure to follow these instructions can result in death, serious injury, or equipment damage.

⁽¹⁾ Earthing in several points is permitted if the connections are made to an equipotential earth surface that is sized to avoid damage to the cable shields in the event of a short circuit in the power supply.

NOTE: The surface temperatures can exceed 60 °C. Lay the main wiring (power wires) separately from the secondary wiring (very low voltage wire coming from intermediate power sources). Where this is not possible, double insulation is required in the form of cable recesses or raceways.

3.1.2. Rules for screw-type terminal boards

The table below illustrates the types of cables and wire sections for a screw-type terminal board with **5.08** or **5.00** spacing:

								
mm ²	0.2...2.5	0.2...2.5	0.25...2.5	0.25...2.5	2 x 0.2...1	2 x 0.2...1.5	2 x 0.25...1	2 x 0.5...1.5
AWG	24...13	24...13	22...13	22...13	2 x 24...18	2 x 24...16	2 x 22...18	2 x 20...16









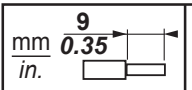

		<table border="1" style="border-collapse: collapse;"> <tr> <td>N•m</td> <td>0.5...0.6</td> </tr> <tr> <td>lb-in</td> <td>4.42...5.31</td> </tr> </table>	N•m	0.5...0.6	lb-in	4.42...5.31
N•m	0.5...0.6					
lb-in	4.42...5.31					
Ø 3,5 mm (0.14 in.)						

Fig. 8. Spacing 5.08 mm (0.20 in.) or 5.00 mm (0.197 in.)

The table below illustrates the types of cables and wire sections for a screw-type terminal board with **3.81** or **3.50** spacing:

								
mm ²	0.14...1.5	0.14...1.5	0.25...1.5	0.25...0.5	2 x 0.08...0.5	2 x 0.08...0.75	2 x 0.25...0.34	2 x 0.5
AWG	26...16	26...16	22...16	22...20	2 x 28...20	2 x 28...20	2 x 24...22	2 x 20



		<table border="1" style="border-collapse: collapse;"> <tr> <td>N•m</td> <td>0.22...0.25</td> </tr> <tr> <td>lb-in</td> <td>1.95...2.21</td> </tr> </table>	N•m	0.22...0.25	lb-in	1.95...2.21
N•m	0.22...0.25					
lb-in	1.95...2.21					
Ø 2,5 mm (0.1 in.)						

Fig. 9. Spacing 3.81 mm (0.15 in.) or 3.50 mm (0.14 in.)

Copper conductors must be used.

DANGER

LOOSE WIRING CAN RESULT IN ELECTRIC SHOCK

- Tighten the connections in compliance with the technical specifications for pairs.
- Do not insert more than one wire in each connector on the terminal board without the ends of the cables specified in the tables given in the information on Rules for screw-type terminal boards.

Failure to follow these instructions will result in death or serious injury.

DANGER

FIRE HAZARD

- Use only the recommended wire sections for current capacity of the I/O channels and the electrical power.
- For wiring an 2 A relay output use conductors with section of at least 0.5 mm² (AWG 20) with a nominal temperature value of at least 80 °C (176 °F).
- For wiring an 3 A relay output use conductors with section of at least 1.5 mm² (AWG 16) with a nominal temperature value of at least 80 °C (176 °F).
- For common relay output wiring of 8 A or over 3 A, use conductors with section of at least 2.0 mm² (AWG 12) with a nominal temperature value of at least 80 °C (176 °F).

Failure to follow these instructions will result in death or serious injury.

3.1.3. Protecting the outputs from damage from inductive loads

Depending on the load a protection circuit may be required for controller outputs and certain modules. Inductive load switching may create voltage impulses that damage or short circuit or reduce the life of the output devices.

CAUTION

DAMAGE TO OUTPUT CIRCUITS DUE TO INDUCTIVE LOADS

Use an external protective device or circuit able to reduce the risks caused by voltage impulses in the switching of inductive loads.

Failure to follow these instructions can result in injury or equipment damage.

If the controller or module has relay outputs, these types of outputs can cope with up to 240 V a.c. Damage from inductive loads to this type of outputs can cause the contacts to weld and lead to the loss of control. Each inductive load must include a protective device such as a peak limiter, an RC circuit or a flyback diode. These relays do not support capacitive loads.

WARNING

RELAY OUTPUTS WELDED TO CLOSED POSITION

- Always protect the relay outputs from damage resulting from alternating current inductive loads using a suitable external protective device or circuit.
- Do not connect the relay outputs to capacitive loads.

Failure to follow these instructions can result in death, serious injury, or equipment damage.

Protection circuit A: this protection circuit can be used for both continuous and alternating current load circuits.

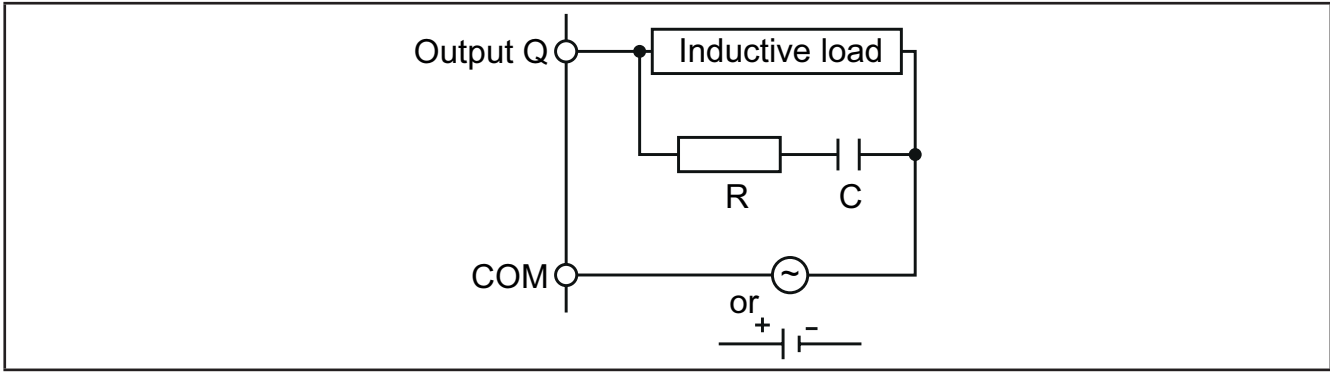

Fig. 10. Protection circuit A

C Value from 0.1 to 1 μ F

R Resistor with approximately the same load resistance value

Protection circuit B: this protection circuit can be used for continuous current load circuits.

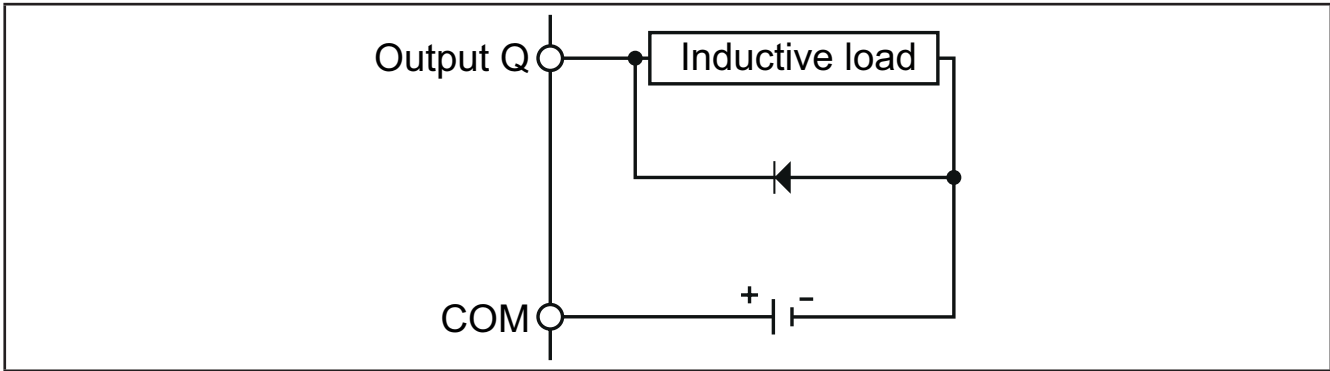

Fig. 11. Protection circuit B

Use a diode with the following nominal characteristics:

- Maximum inverse voltage: load circuit voltage x 10.
- Direct current: greater than the load current.

Protection circuit C: this protection circuit can be used for both continuous and alternating current load circuits.

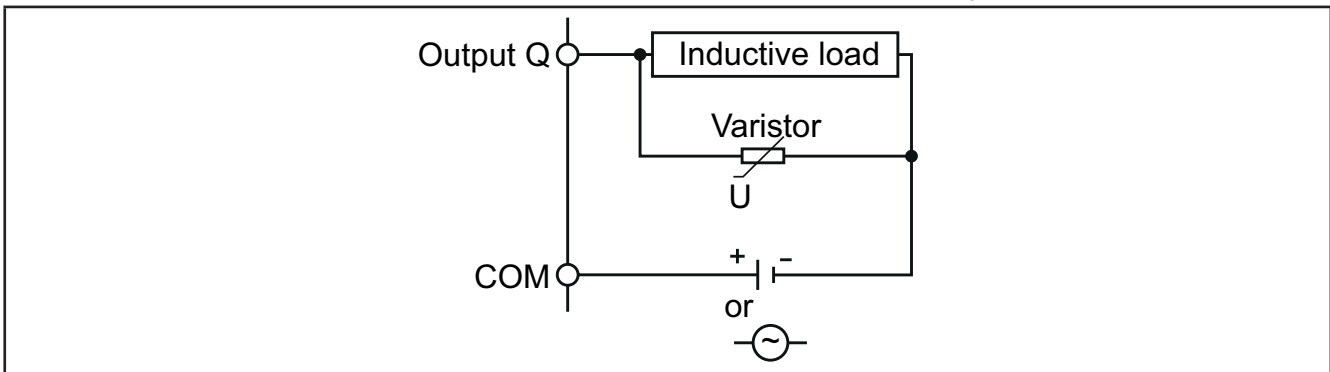

Fig. 12. Protection circuit C

In applications in which the inductive load is frequently and/or rapidly switched on and off, check that the maximum continuous energy (J) of the varistor is 20% or more higher than the peak load energy.

NOTE: Place the protection devices as close as possible to the load.

3.1.4. Specific considerations for handling

When handling the equipment use caution to avoid damage caused by electrostatic discharge. In particular the unshielded connectors and in certain cases the open circuit boards are extremely vulnerable to electrostatic discharge.

⚠ WARNING

FAULTY OPERATION OF EQUIPMENT DUE TO ELECTROSTATIC DISCHARGE

- | |
|---|
| <ul style="list-style-type: none">• Keep the device in the protective packaging until ready for installation.• The device must only be installed in type-approved casings and/or in points that prevent accidental access and provide protection from electrostatic discharge as defined in IEC 1000-4-2.• When handling sensitive equipment, use an antistatic bracelet or equivalent earthed protective device against electrostatic discharge.• Before handling the device, always discharge the static electricity from the body by touching an earthed surface or type-approved antistatic mat. |
|---|

Failure to follow these instructions can result in death, serious injury, or equipment damage.

3.1.5. Analogue inputs-probes

Probes have no connection polarity and can be extended using a normal bipolar cable (note that the extension of the probes influences the instrument's EMC electromagnetic compatibility: take great care with the wiring).

NOTE: probes have a specific insertion polarity which must be observed.

NOTICE

INOPERABLE DEVICE

Before switching on the electrical power, check all the wiring connections.

Failure to follow these instructions can result in equipment damage.

NOTE: apply the electrical power supply to all devices powered externally after applying the electrical power to the **EWCM 436D PRO** controllers.

NOTE: the signal cables (probes, digital inputs, communication and electronic power supply) must be laid separately from the power cables.

3.1.6. Serial connections

TTL

Use a 5-wire TTL cable up to 30 cm in length.

NOTE: the TTL and RS485 serial connections cannot be used at the same time.

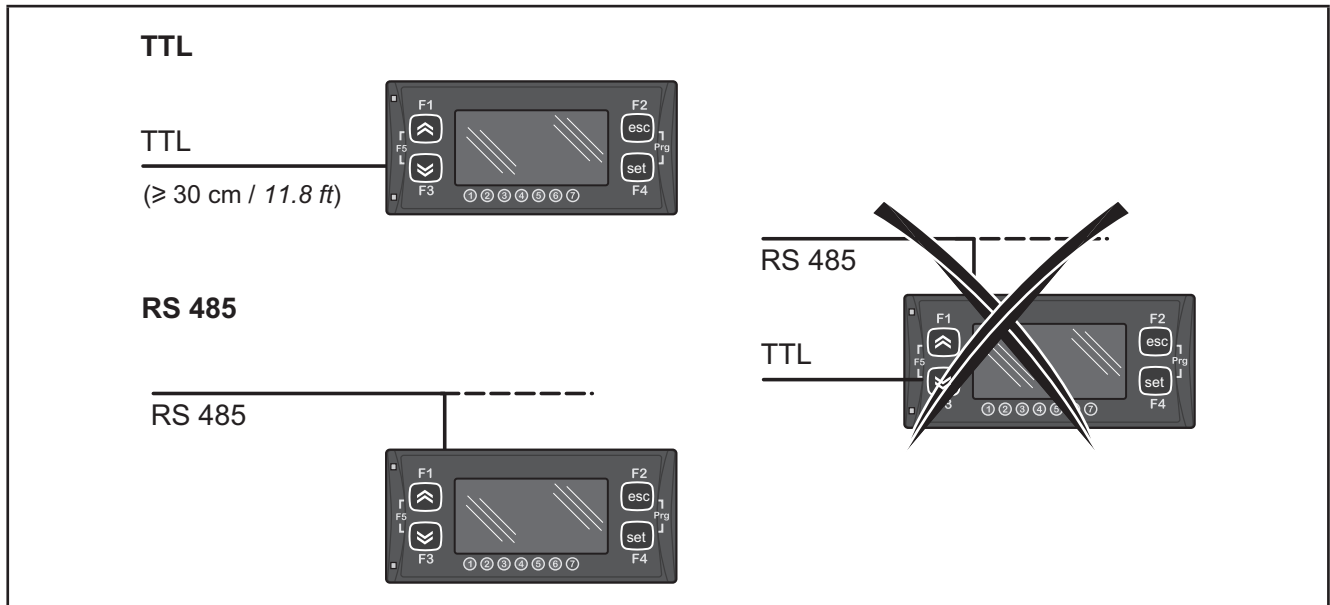

Fig. 13. Serial connection: TTL / RS485

3.2. Wiring diagrams

Incorrect wiring will cause irreversible damage to the controllers.

NOTICE

INOPERABLE DEVICE

Before switching on the electrical power, check all the wiring connections.

Failure to follow these instructions can result in equipment damage.

3.2.1. EWCM 436D PRO A / CRII

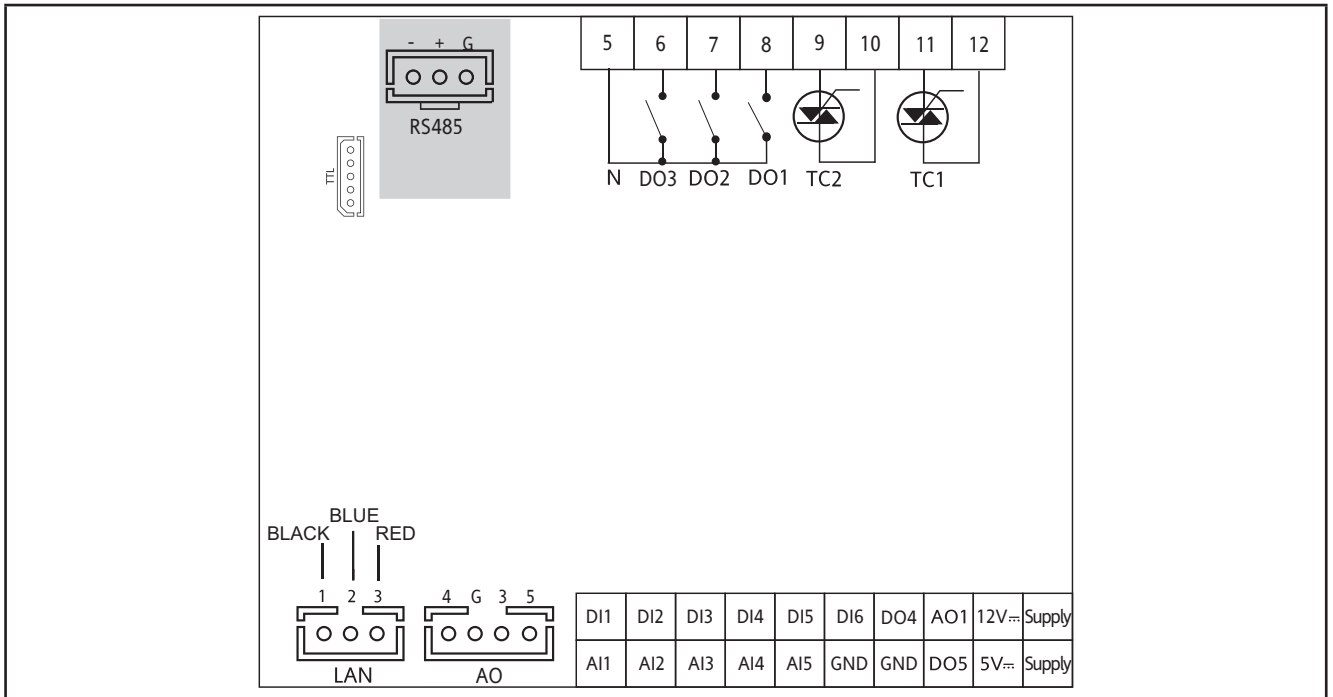

Fig. 14. EWCM 436D PRO

3 digital outputs with high voltage 2 A 240 Vac	[DO1, DO2, DO3]
6 analogue outputs	2 analogue outputs with high voltage 2 A 240 Vac [TC1 TC2]
	1 Open Collector PPM/PWM low voltage analogue output (SELV (§)) [AO1]
	3 low voltage (SELV (§)) analogue outputs
2 0-10 V outputs	[AO3-4]
1 0-10 V or 4...20 mA/0...20 mA output	[AO5]
6 digital inputs	[DI1...DI6]
5 analogue inputs	[AI1...AI5]
3 NTC* / Digital*** inputs	[AI1, AI2, AI5]
2 NTC input / voltage, current** / Digital***	[AI3, AI4]
2 low voltage Open Collector outputs (SELV (§))	[DO4] [DO5]

*Type SEMITEC 103AT (10 kΩ / 25 °C)

**0...20 mA / 4...20 mA current input or 0...5 V / 0...10 V / 0...1 V voltage input

***voltage-free digital input

(°) closing current for 0.5 mA ground

(§) SELV: (SAFETY EXTRA LOW VOLTAGE)

POWER SUPPLY	12-24 Vac
5 Vdc	Auxiliary power supply 5 Vdc. 20 mA max.
12 Vdc	Auxiliary power supply 12 Vdc.
N	Neutral
LAN	SKP 10 (max 100 m)
TTL	TTL serial connection for MFK 100 , UNICARD or DMI
RTC	RTC supplied as standard
RS485	RS485 serial on-board for connection to supervisor

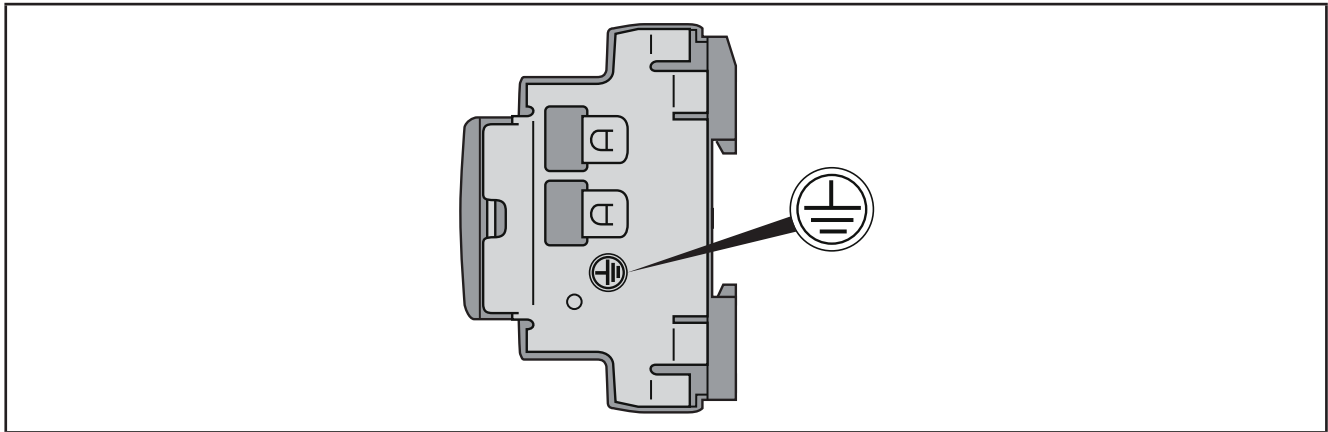

Fig. 15. Ground EWCM 436D PRO

⚡ ⚠ DANGER

RISK OF ELECTRIC SHOCK

Always use the earth connection on the side of the device for safe earthing.

Failure to follow these instructions will result in death or serious injury.

3.2.2. Example of low voltage/low current input/output connection

Example of current/voltage input connection

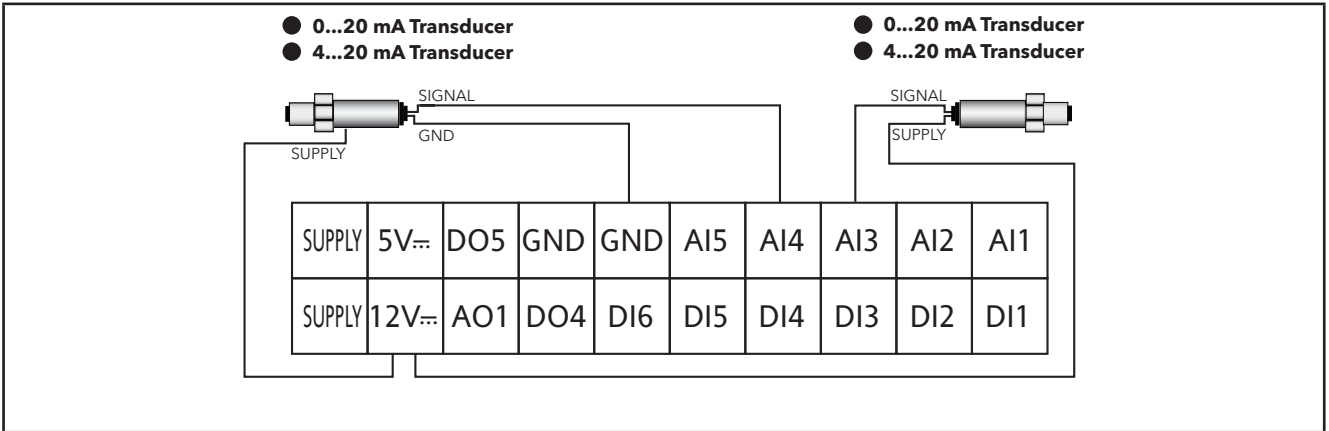

Fig. 16. Current input connection

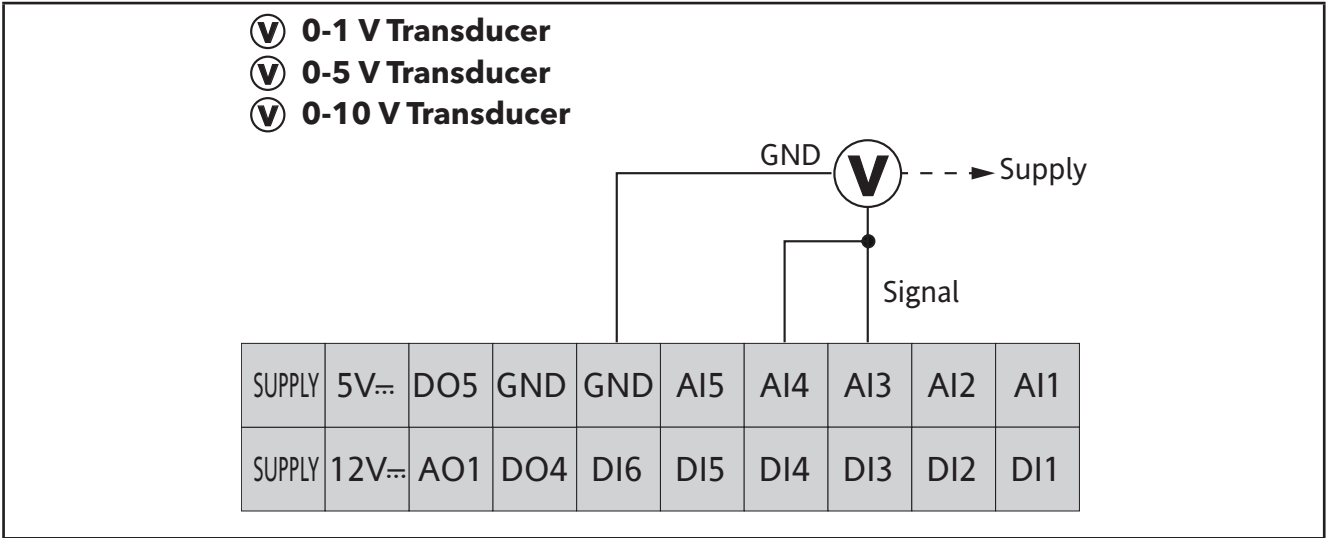

Fig. 17. Voltage input connection

NOTE: In Fig. 17 on page 27, Supply: transducer power supply from **EWCM 436D PRO** (5 V or 12 V). For more information refer to the transducer technical data sheet.

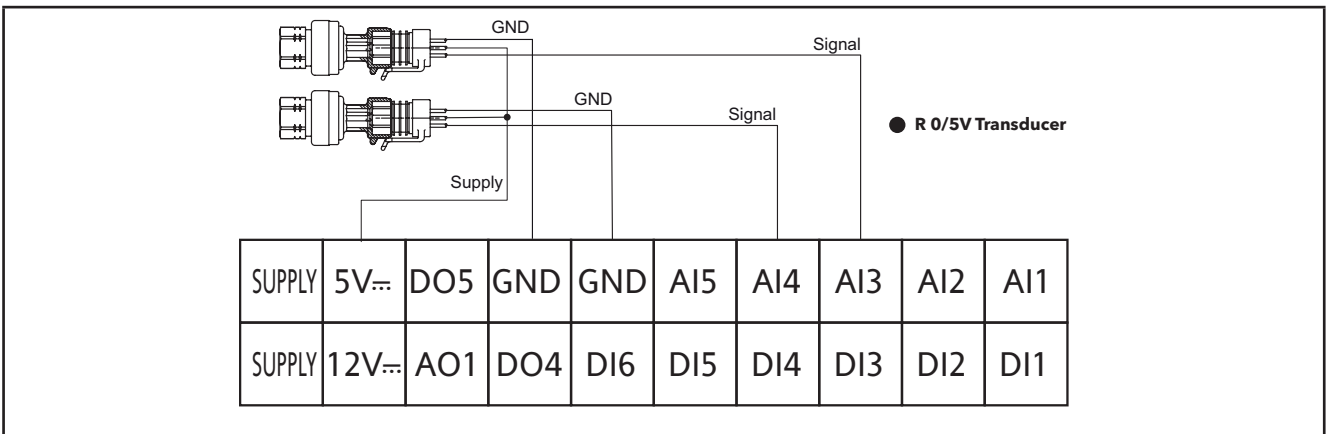

Fig. 18. Voltage connection of ratiometric inputs 0-5 V

Example of analogue/digital input connection

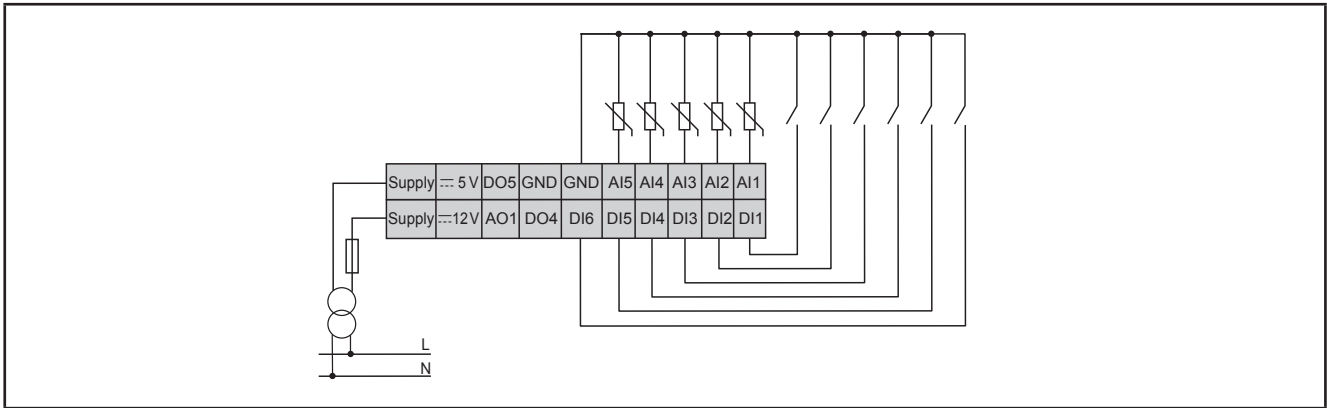

Fig. 19. Example of analogue/digital input connection

Example of AO1 connection

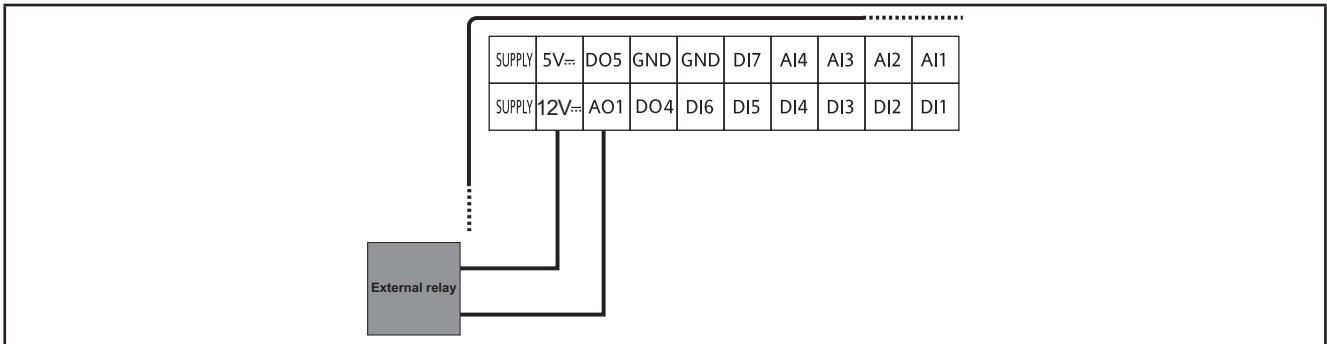
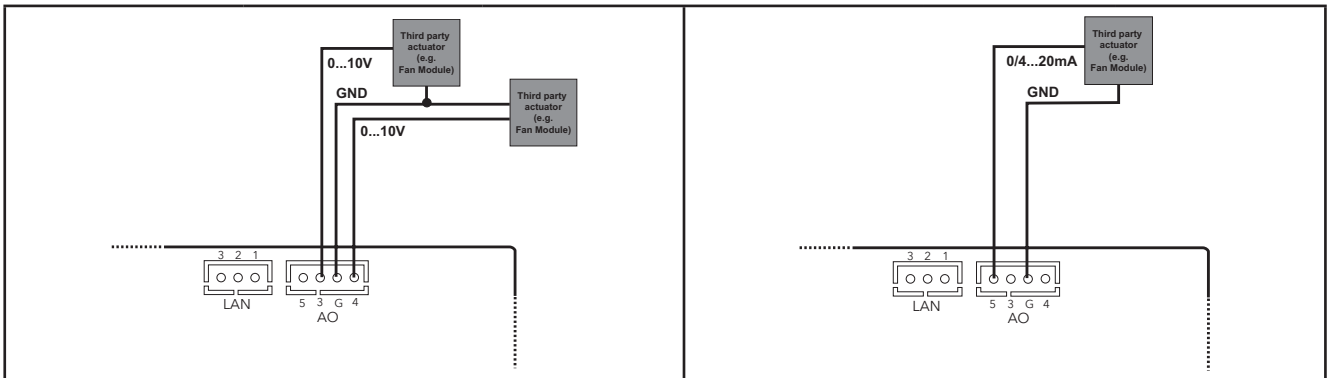

Fig. 20. Example of EWCM 436D PRO connection to an external relay

Example of AO3-AO4 / AO5 connection



Analogue output	Terminal no.	Description	Analogue output	Terminal no.	Description
AO3	3	0..10 V	AO5	5	0-10 V output or 4..20 mA/ 0...20 mA alternatively on dedicated version
AO3	G	GND	AO5	G	GND
AO4	4	0..10 V			
AO4	G	GND			

Fig. 21. Example of EWCM 436D PRO (AO3-AO4) connection with 1 0-10 V fan module

Fig. 22. Example of EWCM 436D PRO (AO5) connection with 1 0...20 mA / 4...20 mA fan module

Example of DO5 connection

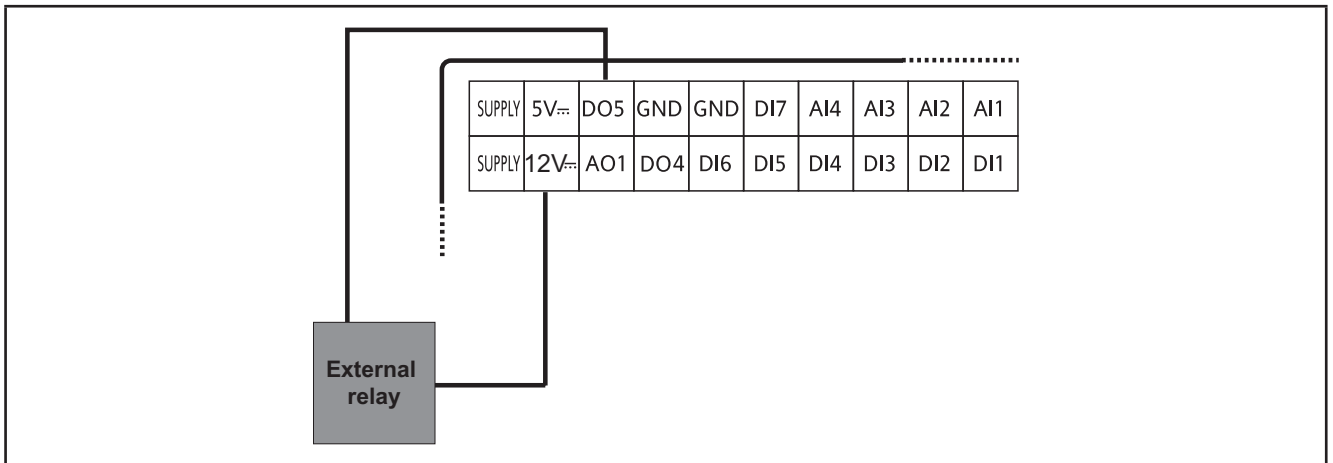

Fig. 23. Example of EWCM 436D PRO connection to an external relay

NOTE: Identical example.

3.2.3. Standard configuration with high voltage outputs

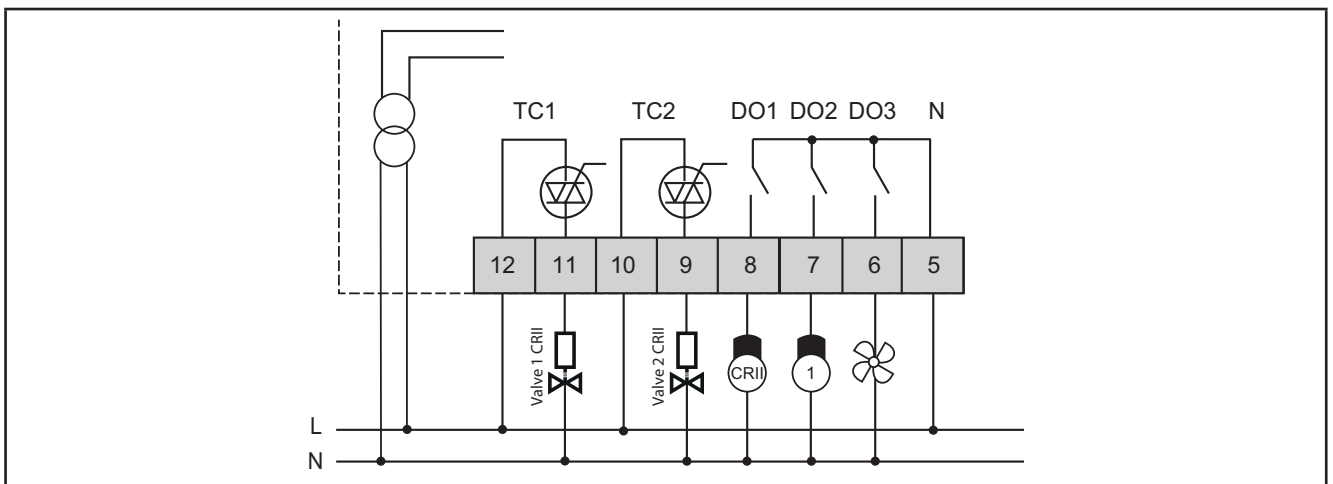

Fig. 24. Example of connection of high voltage outputs

3.2.4. Standard configuration of digital/analogue inputs

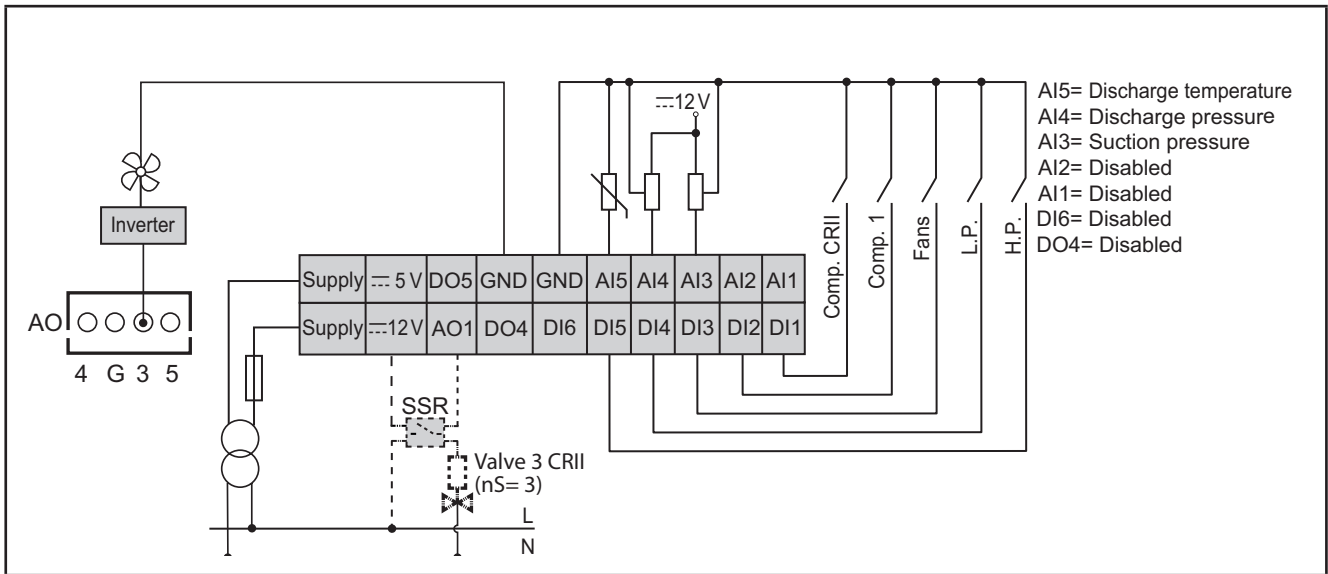

Fig. 25. Standard configuration of digital/analogue inputs

3.3. Example of SKP 10 connection

NOTE: The max distance of the LAN wiring is 100 m.

3.3.1. SKP 10

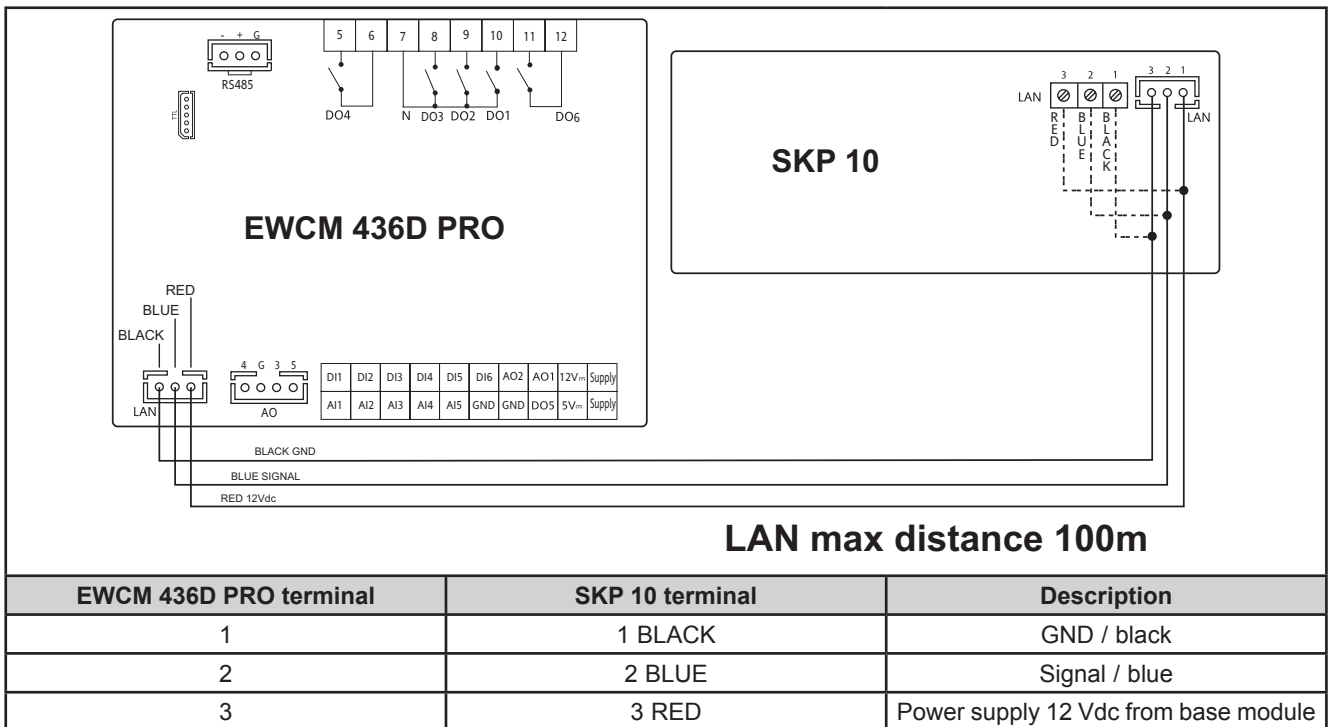

Fig. 26. Connection of EWCM 436D PRO / SKP 10

CHAPTER 4

Technical data

All components in the **EWCM 436D PRO** controllers system meet the European Community (CE) requirements for open devices. They must be installed in a casing or other designated place to suit the environmental conditions and minimise the risk of involuntary contact with high voltages. Use metal casings to improve the immunity of the **EWCM 436D PRO** system to electromagnetic fields. This device meets the CE requirements indicated in the table below.

⚠ WARNING

INCORRECT OPERATION OF THE DEVICE

Do not exceed any of the nominal values specified in this chapter.

Failure to follow these instructions can result in death, serious injury, or equipment damage.

The application of incorrect current and voltage values to the analogue inputs and outputs may damage the electronic circuits. Moreover, connecting a current input device to an analogue input configured for voltage and vice versa will also damage the electronic circuits.

NOTICE

INOPERABLE DEVICE

- Do not apply voltages higher than 11 Vdc. to the analogue inputs of the controller or the input/output expansion module if the analogue input is configured as a 0-10 V input.
- Do not apply currents over 30 mA to the controller analogue inputs or the input/output expansion module when the analogue input is configured as an input 0-20 mA or 4-20 mA.
- Make sure that the signal applied corresponds to the analogue input configuration.

Failure to follow these instructions can result in equipment damage.

4.1. General Specifications

4.1.1. Controller Modules

	Standard	Min.	Max.
NON-INSULATED power supply voltage	12-24 Vac	---	---
Power supply frequency	50 Hz/60 Hz	---	---
absorbed power	6 VA	---	---
Insulation class	II	---	---
Ambient operating temperature	25 °C	-10 °C	65 °C
Operating environment humidity (with no condensation)	30%	10%	90%
Ambient storage temperature:	25 °C	-40 °C	85 °C
Storage environment humidity (with no condensation)	30%	10%	90%

Classification	
The product also complies with the following harmonized standards	EN 60730-1 / EN 60730-2-9
Use	Controller for compressor racks with CRII series compressors
Classification	According to construction as an electronic device to be incorporated via assembly on DIN rail (not for safety)
Installation	EWCM 436D PRO: Mounting on DIN rail SKP 10: Panel mounting
Type of action	1.B - 1.Y
Pollution class	2 (normal)
Over voltage category	II
Nominal pulse voltage	2500 V~
Digital outputs	refer to the label on the device
Fire resistance category	D
Software class	A
Type of disconnection or suspension for each circuit	Microswitch disconnection
Insulating material group	IIIa
Period of electrical stress on the insulating parts	Long period

4.2. I/O features

4.2.1. Controller Modules

Type and Label	Description
Digital inputs DI1 ... DI6	6 voltage-free digital inputs Closure current for ground: 0.5 mA.
High voltage digital outputs DO1 ... DO3	3 relays 2 A 240 Vac;
TC1, TC2	TRIAC 2 A 240 Vac Resolution: 1% Remote control switches downstream from the TRIAC are NOT permitted
Low voltage analogue outputs (SELV) PWM/PPM OC AO1	PWM/PPM Open Collector outputs Accuracy: 2 % Nominal range 0...16,9 Vdc (12 Vac rectified) Closure at 12 Vdc * Max. current 35 mA* (min. load 340 Ω at 12 Vdc)
Low voltage (SELV) analogue output AO3, AO4	0-10 V outputs max 28 mA** at 10 V (min. load resistance 360 Ω) Precision 2% of integral scale Resolution: 1%
AO5	1 0-10 V or 4...20 mA / 0...20 mA output Precision 2% of integral scale Resolution: 1% • 0/4...20 mA output, max load (max load resistance 350 Ω)**
Analogue inputs AI1 ... AI5	See tables (Analogue inputs)
Open Collector low voltage (SELV) digital output DO4, DO5	2 Open Collector outputs * Max. current 35 mA* at 12 Vdc

*The outputs AO1, AO2 and DO5 (usually connected to the device's auxiliary 12Vc output) cannot deliver more than 70mA in all) Also consider any other loads connected to the same 12 Vdc auxiliary output.

If the **SKP 10** keypad is connected to the device, the current becomes 55 mA.

**Outputs AO3, AO4 and AO5 cannot deliver more than 40 mA total

Analogue inputs

	NTC (103AT) 10 kΩ at 25 °C	Current 0-20 mA 4-20 mA	Voltage 0-10 V	Voltage 0-5 V	Voltage 0-1 V	DI
AI1	✓	-	-	-	-	✓
AI2	✓	-	-	-	-	✓
AI3	✓	✓	✓	✓	✓	✓
AI4	✓	✓	✓	✓	✓	✓
AI5	✓	-	-	-	-	✓
Range	-50...100 °C (-58..212 °F)	-	-	-	-	-
Accuracy	1% f.s.	1% f.s.	1% f.s.	1% f.s.	2% f.s.	
Resolution	0.1 °C	0.1	0.1	0.1	0.1	
Input impedance	10 kΩ	100 Ω	21 kΩ	110 kΩ	110 kΩ	

NOTE: DI: Digital input with voltage-free contact.
Probes not included - contact the Eliwell Sales Office for accessories.

4.3. Serial ports

	Label	Description
Serial ports	TTL	1 TTL serial for connection to programming key (MFK 100 / UNICARD) or Personal Computer via interface module
	RS485	Opto-isolated RS485 serial port

4.3.1. Power supply

The electrical power supplies must be classified Safety Extra Low Voltage (SELV) according to IEC 61140. These electrical power sources are isolated between the input and output electrical circuits of the power supply and are separated by ground (earth), PELV systems and other SELV systems.

⚠ ⚠ DANGER

RING GROUND CAUSING ELECTRICAL SHOCK AND/OR EQUIPMENT MALFUNCTION

- Do not connect the connection to 0 V on the power supply/transformer powering this device to an external earth connection (ground).
- Do not connect the connection to 0 V or earth (ground) on the sensors and actuators connected to this device to an external ground connection.
- If necessary, use separate power supplies/transformers to power the sensors and actuators isolated from this device.

Failure to follow these instructions will result in death or serious injury.

In any case, the specified voltage field is not maintained, and the products may not function as expected. Use suitable safety interlocks and voltage monitoring circuits.

⚠ WARNING

RISK OF OVERHEATING AND FIRE

- Do not connect the equipment directly to mains power for all versions
- To power this devices, use exclusively safe isolated power supplies/transformers (SELV).

Failure to follow these instructions can result in death, serious injury, or equipment damage.

The device must be connected to an appropriate power supply/transformer with the following characteristics:

Power supply frequency	50/60 Hz
Power	6 VA min.

NOTICE

INOPERABLE DEVICE

Power the device only with alternating current.

Failure to follow these instructions can result in equipment damage.

Description	Power supply
EWCM 436D PRO Display 22 I/O, Modbus, 2 SSR	12/24 Vac

4.4. Mechanical technical specifications

	Description
	Terminals and connectors
High voltage	1 8-way high voltage male connector Use in combination with the female connector supplied
Low voltage	1 low voltage snap-on 20 way connector For use with COLV0000E0100
	1 4-way connector Use with COLV000042100
RS485 serial	1 3-way connector Use with COLV000035100
	Container
	PC+ABS plastic resin with V0 flammability rating

4.5. Dimensions

	Length (L) mm	Depth (d) mm	Height (H) mm	Notes
Front (cover) EWCM 436D PRO	70	/	45	(+0.2 mm)
Dimensions EWCM 436D PRO	70.2	61.6 56.4 from Din bar to cover	87	4DIN
SKP 10 front cover	74	30	32	(+0.2 mm)
Hole for panel-mounting SKP 10	71	/	29	(+0.2 mm /-0.1 mm)

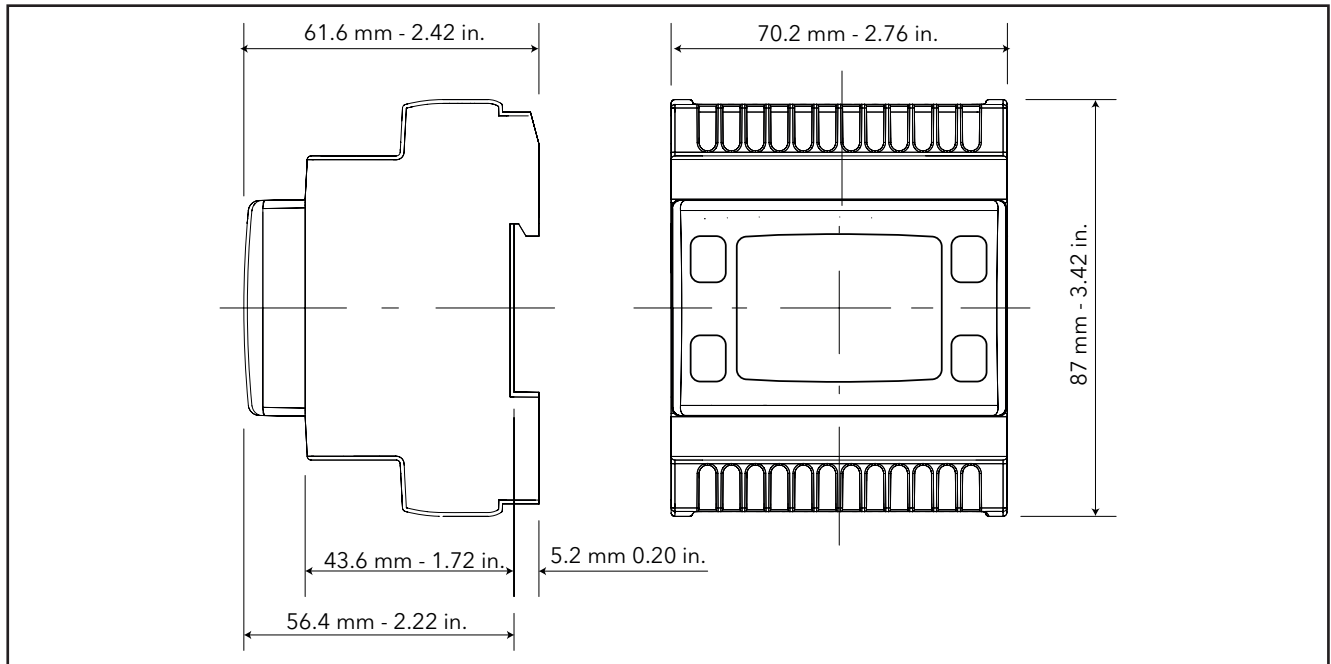

Fig. 27. EWCM 436D PRO

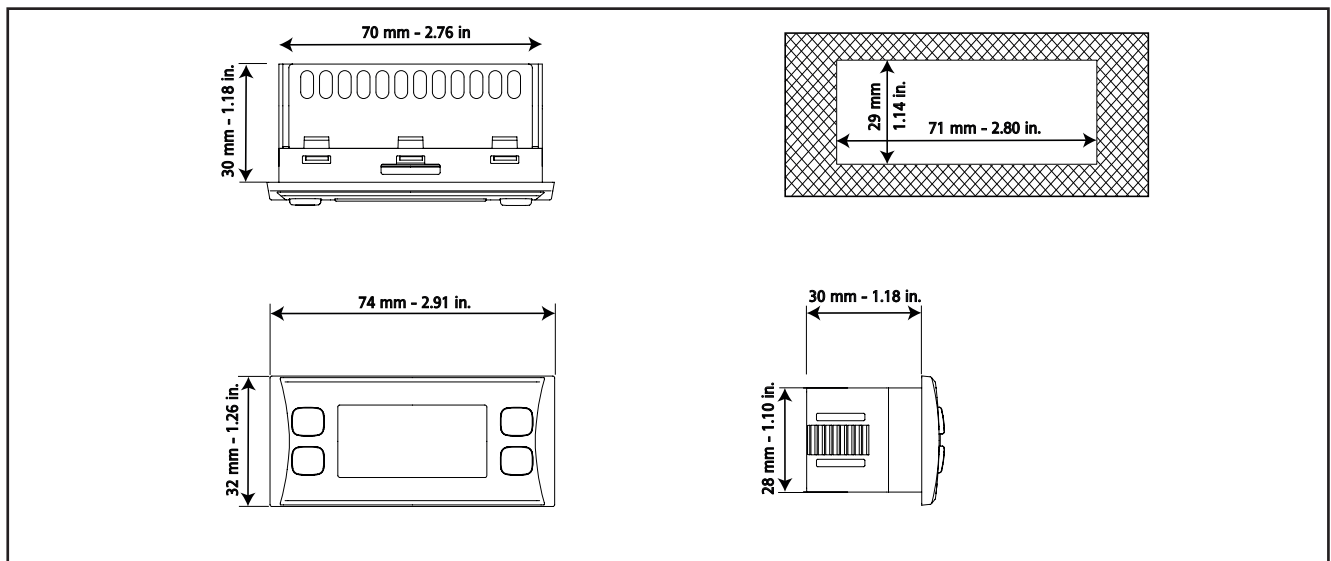

Fig. 28. SKP 10

CHAPTER 5

User Interface (folder PAR/UI)

The interface, comprising the front cover of the controller, allows you to perform all operations needed to use the device.

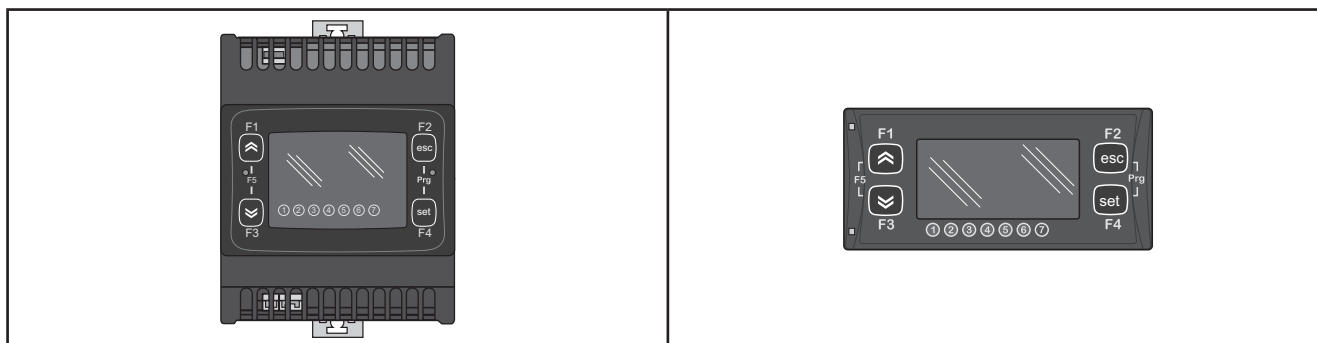

Fig. 29. EWCM 436D PRO

Fig. 30. SKP 10

5.1. Keys

Key	Single press (press and release)	Button [press for Ui26 seconds]
 UP	<ul style="list-style-type: none"> Increase a value. Go to next label Changes the display from suction to discharge in the main screen 	<p style="text-align: center;">F1 A long press will reset the alarm log</p>
<p style="text-align: center;">DOWN</p>	<ul style="list-style-type: none"> Decrease a value Go to previous label Changes the display from suction to discharge in the main screen 	F3
<p style="text-align: center;">esc(ape) Exit (Without saving the new settings)</p>	<ul style="list-style-type: none"> Exit without saving new settings Go back to previous level Changes the display from °C to Bar in the main screen 	F2 (*)
<p style="text-align: center;">Set Confirm (saving new settings)</p>	<ul style="list-style-type: none"> Confirm value / exit and save new settings Move to next level (open folder, subfolder, parameter, value) Open State Menu. 	F4

(*) The display on the main screen can also be switched between °C and Bar from SKP 10 by pressing the esc key (F2) on the keypad for at least 3 seconds.

5.1.1. Description of keys – combined action

Symbol (function associated to combined operation of the keys)	Combined press Single press (press and release)	(associated function)
F5	[F1+F3]	[Can be used to move from the main BIOS menu display to the main A-CR11 application menu]
Prg	[F2+F4]	[Open programming menu]

5.2. LEDs and Display







The display has 18 icons (LEDs) split into 3 categories:







- States and Operating Modes
- Values and Units of Measure
- Utilities



5.2.1. Display

The display shows the value/resource set for the “main display”. Values of up to 4 digits or 3 digits plus sign can be displayed.

5.2.2. LED

LED states and Operating Modes	Icons	Description	Colour
 <p>If there is an alarm, the Alarm icon lights up.</p>		Alarm	Red
		Main display of values read by the discharge probe.	Green
		Main display of values read by the suction probe.	
		Standby	
		Not used	
		Floating condensation enabled	

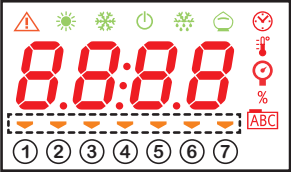
LED Unit of measure	Icons	Description	Colour
		Clock (RTC)	Red
		Degrees centigrade	
		Pressure (Bar)	
		Relative humidity RH% or % of analogue output	
		Menu (ABC)	

LED utilities	Icons	Description	Colour	Default	Users/Groups
		Utility	Amber yellow	CR11 compressor drive	① Configurable from parameter 01u
				CR11 capacity 1	② Configurable from parameter 02u
				CR11 capacity 2	③ Configurable from parameter 03u
				Compressor 1	④ Configurable from parameter 04u
				Digital Fan 1	⑤ Configurable from parameter 05u
				Digital Fan 2	⑥ Configurable from parameter 06u
				Analogue Fan 1	⑦ Configurable from parameter 07u

5.3. First switch-on

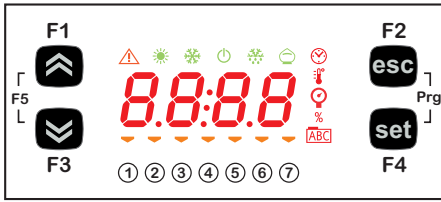

When first switching on, the controller runs a lamp test to check its own integrity and that it is working correctly.

The Lamp Test lasts for a few seconds. In this short time, all the LEDs and figures on the display flash at the same time.

When the controller is switched on the adjustment is always active. In the main screen the device presents the suction probe value in "bar". The user can edit the main screen, see [5.1. Keys on page 37](#). If the instrument is in stand-by it will show "OFF".

5.4. Access to folders - Menu structure

Folders are organized into menus.

Access is defined by the keys on the front cover (see [5.1. Keys on page 37](#)).

The methods of accessing the different menus is given below (or in the chapters indicated).

The device has two Programming menus:

- o BIOS menu, for the "native" configuration of the controller (I/O, various peripherals)
 - o Probe configuration parameters
 - o Communication parameters
 - o Input and output states
- o A/CRII application menu

To access the BIOS menu Press F1+F3 at the same time.

To access the A/CRII application menu Press F2+F4 at the same time.

5.5. BIOS menu

EWCM 436D PRO has a BIOS menu to manage the "States" and "Programming" menu.

5.5.1. BIOS "States" menu

The resource values can be viewed in the states menu.

Label							Description	Edit
Ai	AiL1	AiL2	AiL3	AiL4	AiL5	/	CONTROLLER analogue inputs	/
of	diL1	diL2	diL3	diL4	diL5	diL6	Digital inputs	/
AO	tCL1	AOL1	AOL2	AOL3	AOL4	AOL5	Analogue outputs	/
dO	dOL1	dOL2	dOL3	dOL4	dOL5	/	Digital outputs	/
CL	HOUr	dAtE	YEAr	/	/	/	Alarm	Yes

As shown in the table, the time can be edited and viewed.

Viewing Inputs/Outputs (Ai, di, AO, dO)

Input/output display



To view the inputs/outputs, from the main screen press **set**.

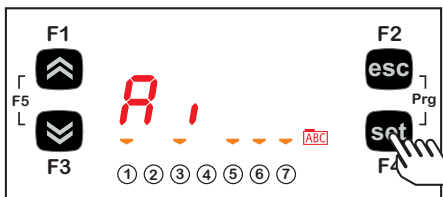

Example of analogue input display For the other I/O*** the same procedure is used

Press **set** once to access a list of the various folders.

Label Ai appears on the display.

(Use **UP** and **DOWN** to scroll through the other labels to find the one required).



Press the **set** key to view the label for the first analogue input (AiL1 in this case).

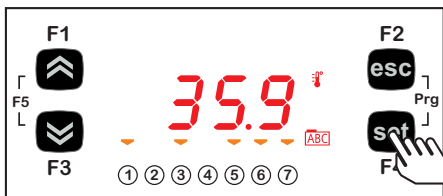

Press the **set** key again to view the value of AiL1. Note that the  icon lights up to indicate that the value shown is in degrees centigrade.

Press the **ESC** key to return to the main display.

***For digital inputs / analogue inputs configured as digital, the value will be:

Value	Analogue	For a digital input this is equivalent to	For the analogue inputs configured as digital this is equivalent to
0	not active	input open	input short circuited to earth
1	active	input short circuited to earth	input open

Setting the clock (CL)

EWCM 436D PRO has a clock (RTC) used to manage the alarm log as a programmable timer thermostat. The instructions on how to set the time are given below: the same procedure can be used to edit the date and year.

Clock settings



To change the time on your machine, starting from the display, press **set**.

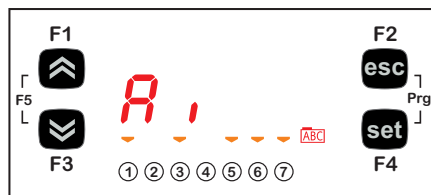

Press **set** once to access a list of the various folders. Scroll the menu using the **UP** and **DOWN** keys until you locate the CL folder.



Press the **set** key to open the CL menu.





Once in you will see HOUR. Use **UP** and **DOWN** to set the time, date or year.

Once you have decided what you want to set, press the **[set]**** key to enter the modification menu for the variable selected.

**long press of about 3 seconds.

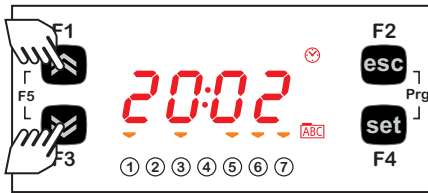

To set the time, date and year, use **UP** and **DOWN** to find the chosen value.



Press **set**.



To exit the time and date settings and return to the main screen, press **esc**.

5.5.2. BIOS programming menu

Parameters	PAr	CL	CF	Ui	---
Functions	FnC	---	---	---	---
Password	PASS	---	---	---	---

Parameters (PAr folder)

The instructions on how to edit a machine parameter are given below. For example, considering the CL configuration parameter folder, parameter **CL00** (folder PAr/CL/CL00).

Editing a parameter



To access the parameters menu, press **esc** and **set** together to enter the PAr menu.

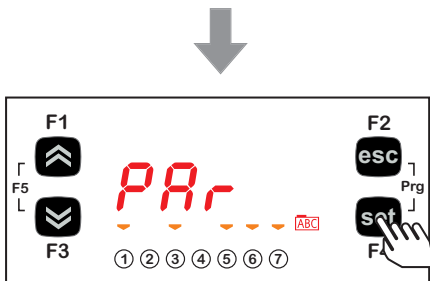

The PAr parameters menu contains all controller parameters. Press the **set** key to view the folders.

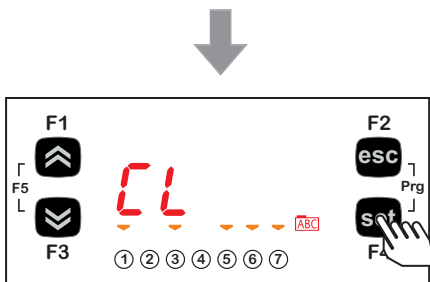

The first folder displayed by the controller will be the CL folder. Press the **set** key again to modify individual dL parameters.

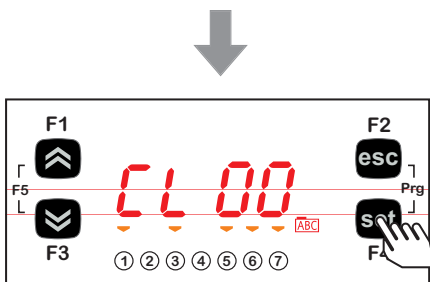

The controller will show parameter **CL00** (factory default settings).

To scroll through the parameters press **UP** to go to the next parameter or to return to the previous one.

To view the value of the parameter press the **set** key.

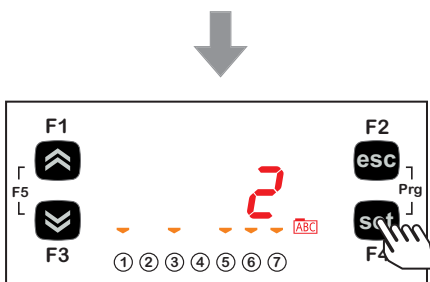

For parameter **CL00**, the value shown will be 2. Use **UP** and **DOWN** keys to change the value.

On selecting a value, press the **set** key. **

To exit this display and return to the previous level, press the **esc** key.

N.B. pressing the **set key confirms the modified value; pressing the **esc** key returns you to the previous level without saving the new value entered.

5.5.3. Functions (folder Par/FnC)

CC folder

The key must be connected to the TTL serial port (See [CHAPTER 12 on page 82](#)) and allows the rapid programming of instrument parameters.

Access the BIOS programming menu, scroll through the folders with **UP** or **DOWN** to view the FnC folder.

Select it with **F4** (Set), scroll through the folders with **UP** or **DOWN** and select with **F4** (Set) (e.g. **CC**).

Scroll through the various parameters available with **UP** or **DOWN** (**UL**, **dL**, **Fr**) and select the required parameter with **F4** (Set):

- Upload (**UL**): select **UL** and press **F4**. This function uploads the programming parameters from the instrument. If the operation is successful, the display will show “**yES**”, otherwise it will show “**Err**”.
- Format (**Fr**): This command is used to format the key.
NOTE: Formatting with the **Fr** function will delete all data present. This operation cannot be reversed.
- Download (**dL**): Connect the key (See [CHAPTER 12 on page 82](#)) when the instrument is switched off. At power-on, data will automatically start downloading from the USB key to the instrument.
At the end of the lamp test, the display will show “**yES**” if the operation was successful and “**Err**” if it failed.

NOTE: After the download, the instrument will use the newly uploaded map settings.

The parameters map can be downloaded when switching on the instrument (Download parameters from reset), using the same procedure described in [Chapter 12.3 on page 83](#).

Setting a password (Par/PASS folder)

Access the PASS folder (from the main display pressing both **esc** and **set** [**esc+set**] and search the folder using **UP/DOWN**). Set the PASS value to view the parameters visible for that password.

Setting the password



To view the PASS folder in the main display, press **esc** and **set** at the same time. [**esc+set**]



Pressing both keys will open the menu containing the list of folders. Use **UP** and **DOWN** to scroll through the list to the PASS folder.

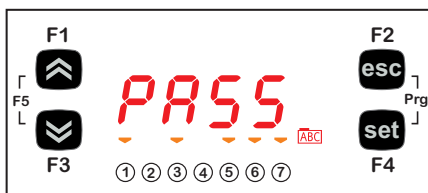

Press **set** to enter the folder PASS. From here, set the password (installer or manufacturer), press **set** and exit.

Now open and view parameters to change a value (see [5.5.2. Bios programming menu on page 43](#)).

5.6. A/CRII application menu

5.6.1. A/CRII states menu

The resource values can be viewed in the “States” menu.

Label							Description
SEt	SP1	SP2	SP01	SP02	/	/	Viewing the operating setpoints
Ai	tSC	PSC	tCd	PCd	tES	tLr	Viewing the probes connected to the device
	tdS	Sb	tSC	Sht	/	/	
SCr	StCr	hS1	dS1	hS2	dS2	hS3	Viewing the CRII compressor operating time
	dS3	/	/	/	/	/	
SC1	StC1	hC1	dC1	/	/	/	Viewing compressor 1 operating time
SC2	StC2	hC2	dC2	/	/	/	Viewing compressor 2 operating time
SC3	StC3	hC3	dC3	/	/	/	Viewing compressor 3 operating time
SC4	StC4	hC4	dC4	/	/	/	Viewing compressor 4 operating time
SFi	StFi	Pid	/	/	/	/	Viewing the fan inverter operating states
SF1	StF1	hF1	dF1	/	/	/	Viewing fan 1 operating time
SF2	StF2	hF2	dF2	/	/	/	Viewing fan 2 operating time
rEL	idF	rEL	tAb	CrCH	CrCL	/	Viewing the device release
HiSt	HYSP	HYSC	HYSd	HYSst	HiSF	/	Display alarms history
AL	Er01 ... Er19		/	/	/	/	Active alarm display

As shown in the table, the time can be edited and viewed.

Viewing the state menu

Viewing the "States" menu



To view the "states" menu, from the main screen press **set**.

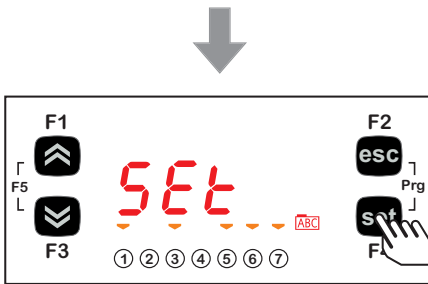

Press **set** once to access a list of the various folders.
Label Set appears on the display.

(Use **UP** and **DOWN** to scroll through the other labels to find the one required).

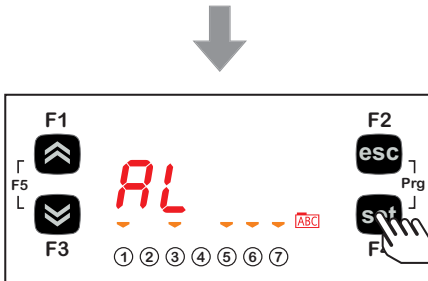

Press the **set** key to view the label for the required folder (AL in this case).



Press the **set** key again to view the value of **Er01**.
Press the **ESC** key to return to the main display.

5.6.2. A/CR11 Programming menu

Programming menu display

Editing a parameter



To access the parameters menu, press **esc** and **set** together to enter the PAR menu.

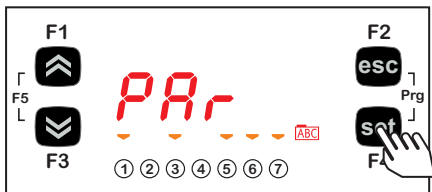

The PAR parameters menu contains all controller parameters. Press the **set** key to view the folders.

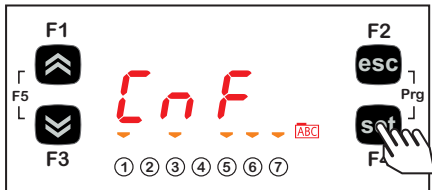

The first folder the controller shows is the CnF configuration folder. Press the **set** key again to modify individual dL parameters.



The controller will show parameter Ert (factory default settings).

To scroll through the various parameters press **UP** to go to the next parameter or **DOWN** to return to the previous one.

To view the value of the parameter press the **set** key.

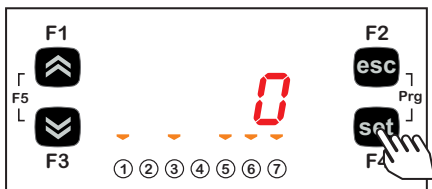

For parameter Ert, the value shown will be 0. Use **UP** and **DOWN** keys to change the value.

On selecting a value, press the **set** key. **

To exit this display and return to the previous level, press the **esc** key.

****Note:** pressing the **set** key confirms the modified value; pressing **esc** returns to the previous level without modifying the set value.

CHAPTER 6

Physical I/O configuration (folder PAR/CL...CR)

The application of incorrect current and voltage values to the analogue inputs and outputs may damage the electronic circuits. Moreover, connecting a current input device to an analogue input configured for voltage and vice versa will also damage the electronic circuits.

NOTICE

INOPERABLE DEVICE

- Do not apply voltages above 11 Vdc to the analogue inputs on the controller or the inputs/outputs expansion module when the analogue input is configured as a 0-10 V input.
- Do not apply currents over 30 mA to the controller analogue inputs or the input/output expansion module when the analogue input is configured as an input 0-20 mA or 4-20 mA.
- Make sure that the signal applied corresponds to the analogue input configuration.

Failure to follow these instructions can result in equipment damage.

6.1. Analogue inputs

There are a total of 5 analogue inputs referred to below as AiL1...AiL5.

Using the parameters, a physical resource (probe, digital input, voltage/current signal) can be “physically” configured for each type of input:

- 3 inputs can be configured as temperature probes (NTC type probe) or as digital inputs.
- 2 inputs (AiL3 and AiL4) can be configured as temperature probes, an NTC type probe, as digital inputs or current/voltage input (signal 0-20 mA / 4-20 mA / 0-10 V, 0-5 V, 0-1 V).

Par.	Description	0	1	2	3	4	5	6	7	8
CL00	AiL1 analogue input type	Probe not configured	Probe configured as voltage-free digital input	NTC sensor	//	//	//	//	//	//
CL01	AiL2 type analogue input	Probe not configured	Probe configured as voltage-free digital input	NTC sensor	//	//	//	//	//	//
CL02	AiL3 type analogue input	Probe not configured	Probe configured as voltage-free digital input	NTC sensor	4-20 mA	0-10 V	0-5 V	0-1 V	0-20 mA	//
CL03	AiL4 analogue input type	Probe not configured	Probe configured as voltage-free digital input	NTC sensor	4-20 mA	0-10 V	0-5 V	0-1 V	0-20 mA	//
CL04	AiL5 analogue input type	Probe not configured	Probe configured as voltage-free digital input	NTC sensor	//	//	//	//	//	//

Parameter	AI analogue input	Range	Description
CL10	AiL3	CL11...999.9	AiL3 analogue input integral scale value
CL11	AiL3	-999.9...CL10	AiL3 analogue input start of scale value
CL12	AiL4	CL13...999.9	AiL4 analogue input integral scale value
CL13	AiL4	-999.9...CL12	AiL4 analogue input start of scale value

Parameter	Description	Unit of measure	Range
CL20	AiL1 analogue input differential	°C	-12.0..12.0
CL21	AiL2 analogue input differential	°C	-12.0..12.0
CL22	AiL3 analogue input differential	°C / Bar	-12.0..12.0
CL23	AiL4 analogue input differential	°C / Bar	-12.0..12.0
CL24	AiL5 analogue input differential	°C	-12.0..12.0

6.2. Digital inputs

There are 6 voltage-free digital inputs, identified below as DI1...DI6.

6.3. Digital outputs

See **CHAPTER 3 Electrical connections on page 19** for the number and capacity of relays/open collectors and for information on the symbols used on labels supplied with the device.

- Power supply - High voltage outputs, relay.
- Low voltage (SELV) outputs, open collector.

The digital outputs are identified as DO1 ... DO5.

6.4. Analogue outputs

See **CHAPTER 3 Electrical connections on page 19** for the number and type of analogue outputs used and for information on the symbols used on labels supplied with the controller.

There are 6 analogue outputs: high voltage output/s and low voltage (SELV) outputs, the exact number of which depends on the version and which have the following characteristics:

Table A – Analogue outputs

Output	Label on display	High voltage	SELV		
		EWCM 436D PRO	Open Collector PWM/ PPM analogue outputs	0-10 V	0..20 mA 4..20 mA
TC1	TCL1	2 A 240 Vac	//	//	//
TC2	AOL2	2 A 240 Vac	//	//	//
AO1	AOL1	//	●	//	//
AO3	AOL3	//	//	●	//
AO4	AOL4	//	//	●	//
AO5	AOL5	//	//	●	●

TRIAC analogue outputs (TC1, TC2)

A high voltage TRIAC output is used to control coils 1 and 2 on the CR11 compressor.

The TRIAC TC1, TC2 output, when partialized, suppresses the half-wave at the zero-crossing.

The AO1 output is configured to control the third valve on the CR11 compressor (**ns** = 3).

⚠ WARNING

INCORRECT OPERATION OF THE DEVICE

Do not install contactors or other interposition relays downstream from the Triac outputs.

Failure to follow these instructions can result in death, serious injury, or equipment damage.

Configuration of low voltage (SELV) analogue outputs

AO3-AO4	AO5
0-10 V low voltage (SELV) output for controlling external modules (e.g. fan control)	Low voltage (SELV) output for controlling external modules (e.g. fan control). It can be used to control 4-20 mA fans or 0-20 mA fans (via parameter CL60) or 0-10 V.

To configure, see the table below. All analogue outputs can be configured as digital or proportional.

Analogue output SELV AO3-4-5		
Parameter	Description	Values
CL60	AOL5 type analogue output	0 = 0-20 mA Analogue output in current on dedicated version 1 = 4-20 mA Analogue output in current on dedicated version 2 = 0-10 V Analogue output in voltage

The following can be piloted:

- Loads with output modulation or
- Loads with on/off type switching using
 - o the output as 0-10 V switch (AO3-4).
 - o the output as a 0-10 V (AO5) switch or 4...20 mA/0...20 mA.

CHAPTER 7

Device configuration (folder PAR/CnF...LEd)

The **EWCM 436D PRO** controllers are programmed to manage CRII compressor racks with two or three solenoid valves. The CRII compressor is controlled via outputs TRIAC TC1, TC2.

To manage a third valve, set the parameter **nS=3** and connect an external relay to the isolated solid state (SSR), to the analogue output AO1.

NOTICE

INOPERABLE DEVICE

Control the third CRII valve exclusively via an isolated SSR relay conforming to the regulations in force, connected to the analogue output AO1.

Failure to follow these instructions can result in equipment damage.

NOTICE

INOPERABLE DEVICE

Power the device only with alternating current.

Failure to follow these instructions can result in equipment damage.

In addition to controlling the CRII compressor, the **EWCM 436D PRO** control is able to control up to 4 On / Off compressors without capacity control.

7.1. Device configuration parameters

In the folder **CnF** it is possible to configure:

- Select refrigerant type;
- Select number of compressors managed in addition to the CRII compressor;
- Select number of compressors on if there is a suction probe error;
- Select number of solenoid valves on the CRII compressor;
- Select number of digital and analogue fans;
- Enable temperature probes.

7.1.1. Type of refrigerant

Using parameter **Ert** it is possible to configure the type of refrigerant used in the system.

Parameter	Description	Values
Ert	Select type of gas	0 = R404A; 1 = R22; 2 = R744; 3 = R290; 4 = R134a; 5 = R407C; 6 = R410A; 7 = R427A; 8 = R507A; 9 = R407A; 10 = R717; 11 = R407F; 12 =R450; 13-14 = R448A; 15 = R513A; 16 = R449A.

7.1.2. Number of compressors - ON/OFF

Using parameter **CPn** it is possible to select the number of compressors managed by the **EWCM 436D PRO** controller in addition to the CR11 compressor.

Parameter	Description	Values
CPn	Number of compressor steps per circuit	0 = No compressor; 1 = 1 Compressor; 2 = 2 Compressors; 3 = 3 Compressors; 4 = 4 Compressors.

Number of compressors on with probe failure

It is possible to configure the number of compressors that remain forced on if there is a suction probe error using parameter **CPE**.

Parameter	Description	Values
CPE	Default regulator power value when suction probe error occurs	0 = No compressor on; 1 = 1 Compressor on; 2 = 2 Compressors on; 3 = 3 Compressors on; 4 = 4 Compressors on.

7.1.3. Number of CR11 compressor solenoid valves

It is possible to configure the number of CR11 compressor valves, via the parameter **nS**.

Parameter	Description	Values
nS	Number of solenoid coil CR11 compressor	2 = 2 CR11 coils (valves); 3 = 3 CR11 coils (valves).

7.1.4. Managing the digital and analogue fans

The **EWCM 436D PRO** controller can manage up to 2 digital outputs to manage the digital fans and up to one analogue output to control the EC fans via the inverter.

Parameter	Description	Values
nFn	Number of digital fans	0 = No digital output configured for fan control; 1 = 1 digital output configured for fan control; 2 = 2 digital outputs configured for fan control.
nFA	Number of analogue fans	0 = No analogue output configured for Inverter control; 1 = 1 digital output configured for Inverter control.

7.1.5. Temperature probe enabling

The **EWCM 436D PRO** controller can manage up to 4 analogue inputs for managing machine alarms and floating condensation. They are enabled by the parameters:

Parameter	Description	Values
FtE	Enable discharge external temperature probe to block the CR11 compressor in the event of an alarm.	0 = disabled; 1 = enabled.
CtE	Enable suction temperature probe to manage High and Low superheating alarm on suction.	
EeT	Enable external temperature probe for floating condensation.	
ELr	Enable liquid return temperature probe to calculate superheating or for floating condensation.	

7.2. I/O configuration parameters

7.2.1. Configuration of analogue inputs

The **EWCM 436D PRO** controller can manage 5 analogue inputs of which:

- 3 analogue inputs configurable as temperature inputs, from parameters:

Parameter	Description	Value
01P	AI1	0 = Disabled 1 = External temperature 2 = Liquid Return Temperature 3 = Discharge temperature 4 = Suction temperature
02P	AI2	
05P	AI5	

- 2 analogue inputs configurable as pressure inputs, from parameters:

03P	AI3	0 = Disabled 1 = Suction pressure 2 = Discharge Pressure
04P	AI4	

7.2.2. Configuration of analogue outputs

The **EWCM 436D PRO** controller can manage 6 analogue outputs, of which:

- 2 TRIAC TC1 and TC2 outputs, non configurable. They manage only valves 1 and 2 on the CR11 compressor;
- 1 analogue output AO1 non configurable. If the parameter **nS** = 3 the analogue output will manage an external solid state relay (SSR) which will control the third valve on the CR11 compressor.
- 2 analogue outputs AO3, AO4 type 0...10 V configurable from parameters:

Parameter	Description	Value
03n	AO3	0 = Disabled; ±1 = CR11 compressor drive; ±2 = Alarm Output; ±3 = Compressor 1 drive; ±4 = Compressor 2 drive; ±5 = Compressor 3 drive; ±6 = Compressor 4 drive; ±7 = Digital Fan 1; ±8 = Digital Fan 2; ±9 = Enable Inverter Fan; 10 = Inverter Fan (analogue) - The '+' sign indicates that the output is active when the contact is closed. - The '-' sign indicates that the output is active when the contact is open. NOTE: For values ±1 ... 9, the outputs will act as On/Off
04n	AO4	

- 1 analogue output AO5 type 0-10 V o 4...20 mA / 0...20 mA, configurable from parameter:

Parameter	Description	Value
05n	AO5	0 = Disabled; 1 = Inverter.

7.2.3. Configuration of digital inputs

The **EWCM 436D PRO** controller has 6 digital inputs, configurable from parameters:

Parameter	Description	Value
di1	i01	0 = Disabled; ±1 = CR11 compressor thermal switch; ±2 = Compressor 1 thermal switch; ±3 = Compressor 2 thermal switch; ±4 = Compressor 3 thermal switch; ±5 = Compressor 4 thermal switch; ±6 = Fan thermal switch; ±7 = Maximum pressure switch; ±8 = Minimum pressure switch; ±9 = Remote on-off; ±10 = Enable reduced discharge set; ±11 = Enable reduced suction set. - The '-' sign indicates that the input is active when the contact is open. - The '+' sign indicates that the input is active when the contact is closed.
di2	i02	
di3	i03	
di4	i04	
di5	i05	
di6	i06	

7.2.4. Digital output configuration

The **EWCM 436D PRO** controller has 5 digital outputs configurable from parameters:

Parameter	Description	Value
d01	dO1	0 = Disabled; ±1 = CR11 compressor drive; ±2 = Alarm Output; ±3 = Compressor 1 drive; ±4 = Compressor 2 drive; ±5 = Compressor 3 drive; ±6 = Compressor 4 drive; ±7 = Digital Fan 1; ±8 = Digital Fan 2; ±9 = Enable Inverter Fan. - The '+' sign indicates that the output is active when the contact is closed. - The '-' sign indicates that the output is active when the contact is open.
d02	dO2	
d03	dO3	
d04	dO4	
d05	dO5	

7.2.5. LED configuration

The LEDs on the display can be configured from the parameters, in the LED folder.

Parameter	Description	Value
01u	Configuration of LED 1	0 = Disabled; 1 = CR11 compressor drive; 2 = Alarm Output; 3 = CR11 compressor capacity 1; 4 = CR11 compressor capacity 2; 5 = CR11 compressor capacity 3; 6 = Compressor 1; 7 = Compressor 2; 8 = Compressor 3; 9 = Compressor 4; 10 = Digital Fan 1; 11 = Digital Fan 2; 12 = Analogue Fan 1.
02u	Configuration of LED 2	
03u	Configuration of LED 3	
04u	Configuration of LED 4	
05u	Configuration of LED 5	
06u	Configuration of LED 6	
07u	Configuration of LED 7	

CHAPTER 8

Compressors

The **EWCM 436D PRO** controller bases its adjustment on the suction pressure.

8.1. Type of compressors supported

The **EWCM 436D PRO** controller can manage:

- 1 CRII compressor with up to 3 valves;
- from 1 to 4 compressors with no capacity adjustment (On/Off).

8.2. System configurations supported

The following types of suction systems can be used:

No.	Description	Par. value CPn	nS par. value
1	One CRII compressor with 2 valves	0	2
2	One CRII compressor with 2 valves and one single compressor	1	2
3	One CRII compressor with 2 valves and 2 single compressors	2	2
4	One CRII compressor with 2 valves and 3 single compressors	3	2
5	One CRII compressor with 2 valves and 4 single compressors	4	2
6	One CRII compressor with 3 valves	0	3
7	One CRII compressor with 3 valves and one single compressor	1	3
8	One CRII compressor with 3 valves and 2 single compressors	2	3
9	One CRII compressor with 3 valves and 3 single compressors	3	3
10	One CRII compressor with 3 valves and 4 single compressors	4	3

8.3. Overview of compressor control

The purpose of the compressor unit is to maintain the suction pressure within a band around a given Setpoint.

In the compressor on-off chain, the CRII is always the first to come on and the last to go off.

The CRII compressor capacity is modulated via the solenoid valves which are installed to charge and discharge the compressor.

When the solenoid valve is not actuated (TC output = 0 Vac) the compressor presses on the cylinder head, when actuated (TC output = 230 Vac) the compressor releases the pressure.

The modulation follows the up and down pressure trends. If the pressure rises the modulating valve on the CRII compressor is enabled, when it drops it is disabled. If the pressure rises more the power requested from the CRII is increased and another valve is activated. When the power increases further, the digital compressors are also switched on.

The **EWCM 436D PRO** controller activates the CRII compressor valves according to their running time. When the compressor comes on, the controller starts to modulate the TRIAC TC1 or TC2 output with a shorter running time. In the same way, also for the single compressors, the choice of compressor to be switched on, among those which are off, is always based on the one with the shortest running time

These are stored in the non volatile memory and can be viewed in the application state menu, in the folders:

Folder	Description
SCr	Display of CRII compressor running time
SC1	Display of compressor 1 running time
SC2	Display of compressor 2 running time
SC3	Display of compressor 3 running time
SC4	Display of compressor 4 running time

It is possible to reset the running time in the PRG programming menu, in the rSt folder.

A CRII compressor can modulate its capacity according to request, from 10% to 100%.

8.3.1. CRII compressor on mode

When the CRII compressor is off and the safety times defined for parameters **OFc** and **OnC** have expired the compressor comes on if the suction pressure is above the internal upper band for $\geq \mathbf{dH}$. When switched on, the first TC valve also comes on. When the pressure conditions for switching on are met but the time on passed is less than **dH** led 1 on the display flashes. When the compressor comes on, led 1 comes on without flashing and at the same time led 2 or 3 or 4 come on, depending on the valve controlled. If the pressure falls to within the band before time **dH expires**, led 1 stops flashing and the compressor does not come on.

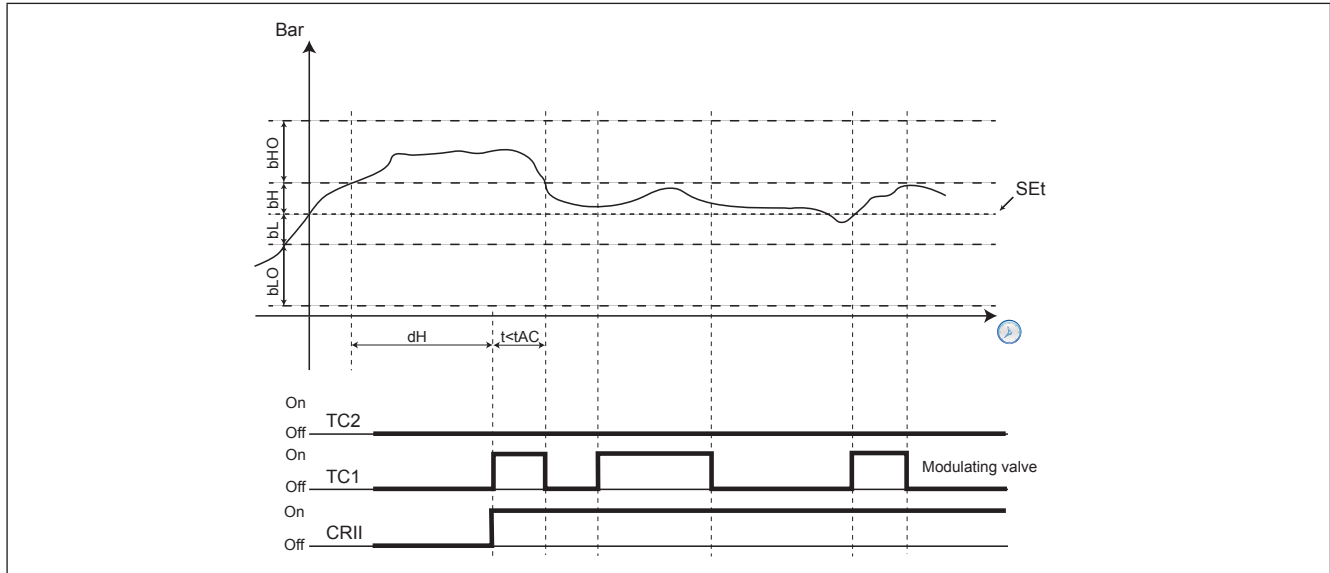

Fig. 31. CRII compressor on

8.3.2. Modulation of CRII valves and safety times

The compressor must be on for the valves to modulate. When switching on, the **EWCM 436D PRO** controller activates the valve with the shortest running time, which becomes the modulating valve.

The parameters determining the minimum on and off times are respectively **OnS** and **OFS**.

Whenever a valve is enabled or disabled, the time in which the valve is on or off is counted.

If a valve is active, and remains so for longer than **OnS** or once disabled, it stays off for longer than **OFS**, no protection will affect the subsequent control.

The TC outputs cannot:

1. Be activated or deactivated for a shorter time than the period defined by parameters OnS and OFS;
2. Be activated and deactivated within a cycle representing the sum of the parameters OnS and OFS.

The controller automatically determines which of the 2 rules to apply, based on the operating time of the TC outputs.

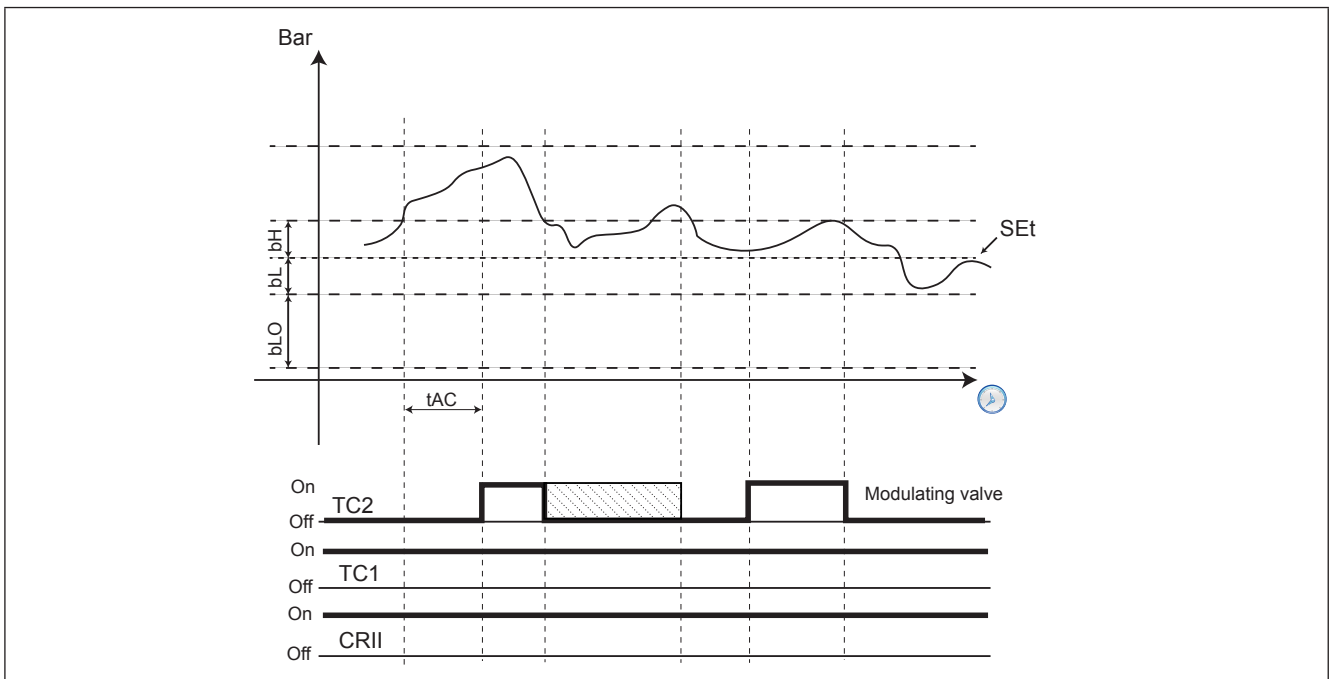

Fig. 32. Protection time

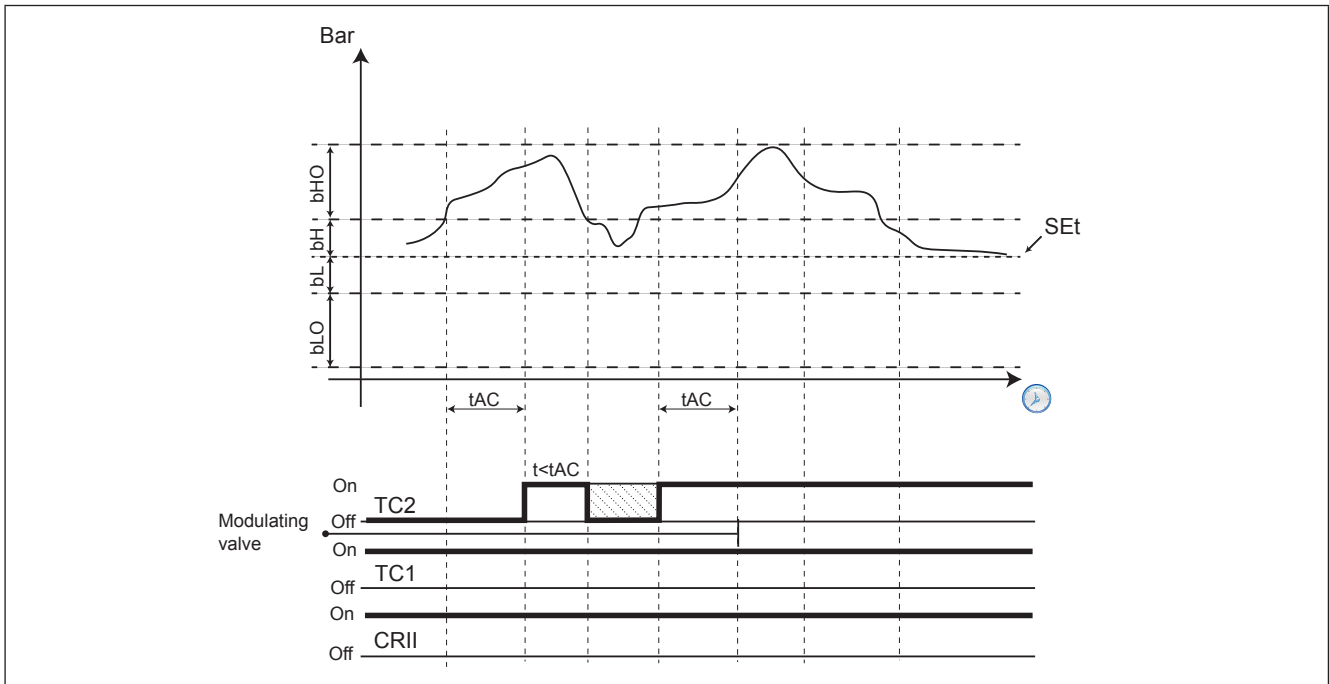

Fig. 33. TC2 from modulating to active

The modulating valve is switched when the pressure is between the Setpoint and the upper limit of the internal band. The modulation follows the up and down pressure trends. If the pressure rises the modulating valve is activated, when it drops it is disabled. If the pressure rises too far and exceeds the upper limit of the internal band for longer than t_{AC} , the power requested from the CRII is increased, consequently enabling another valve (if available). The last valve activated automatically becomes the new modulating valve, while the previous one will always remain active until the conditions for off or those for which it becomes the modulating valve again, are met. If the pressure returns to within the internal upper limit before the time limit t_{AC} , no power increase is requested and the modulating valve is disabled. All of this occurs respecting the above-described logic of the protection timers. The time the pressure must remain out of range to activate a new valve is equal to $t_{AC}/2$ if the pressure exceeds the upper limit of the external range.

When the suction pressure is between the internal lower range and the Setpoint the state of the CRII compressor and its valves is crystallised (the valve state does not change).

When the pressure falls below the internal lower range for more than tdC the usage power of the CRII is decreased one step. For each subsequent period tdC that passes with the pressure below the range limit, the CRII power decreases one step. Until no valves are active. Only at this point will it be possible to start the CRII compressor switch-off procedure

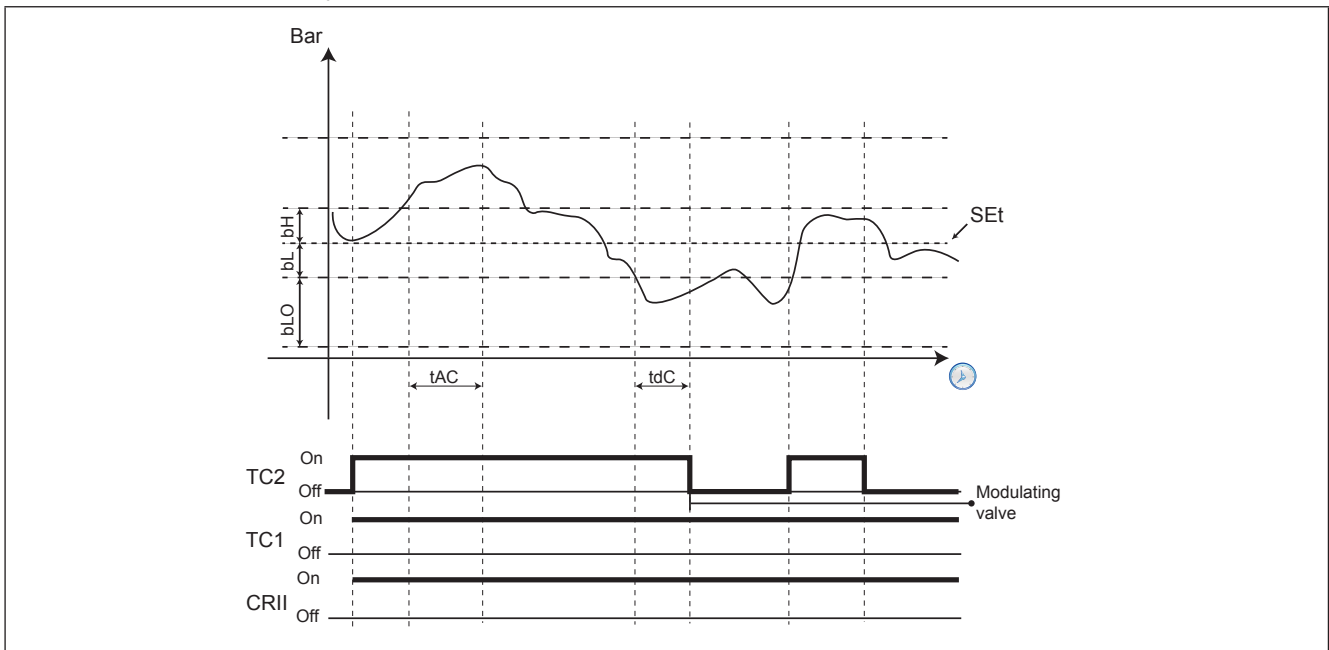

Fig. 34. Valve switch-off mode

8.3.3. Single compressor switch-on mode

If the last CRII valve available is activated as a modulating valve and despite its action the pressure remains above the internal upper range for more than **tAC** (**tAC/2** if higher than the external upper range), the modulating valve becomes fixed on and if the suction pressure continues to remain out of range for longer than **dH** then, if one or more single compressors are working to support the CRII, a further increase in power is requested when switching on the first single compressor available with the shortest period of use. Every single other increase in power is required only if On/Off compressors are available and the pressure exceeds and remains out of range for longer than **dH**. If the pressure exceeds the most external range (**bH+bHO**) the time spent out of range required for the power increase request is equal to **dHO**. The concept of safety times applies also to single compressors and must be respected.

8.3.4. Switching off single compressors

Single compressors are switched off according to the On-Off and Off-On safety times, determined by parameters:

Parameter	Description
OF1	OFF to ON compressor safety time in the suction section 1
OF2	OFF to ON compressor safety time in the suction section 2
OF3	OFF to ON compressor safety time in the suction section 3
OF4	OFF to ON compressor safety time in the suction section 4
On1	ON to ON compressor safety time in the suction section 1
On2	ON to ON compressor safety time in the suction section 2
On3	ON to ON compressor safety time in the suction section 3
On4	ON to ON compressor safety time in the suction section 4

The conditions for switching off single compressors are:

- CRII compressor with only one valve active as a modulating valve;
- Suction pressure lower than the internal range for **dL** (**dLO** for pressure lower than the external lower range).

If both conditions are respected, the compressor with the shortest running time is switched off.

Afterwards, one by one the other single compressors active will be switched off with a delay of **dLO** between one and the next.

8.3.5. Switching off the CRII compressor

The conditions governing the switching off of the CrII compressor are:

- Both CRII valves disabled;
- All single compressors disabled.

Both the conditions must be satisfied for at least **tOF** before the CRII compressor is switched off.

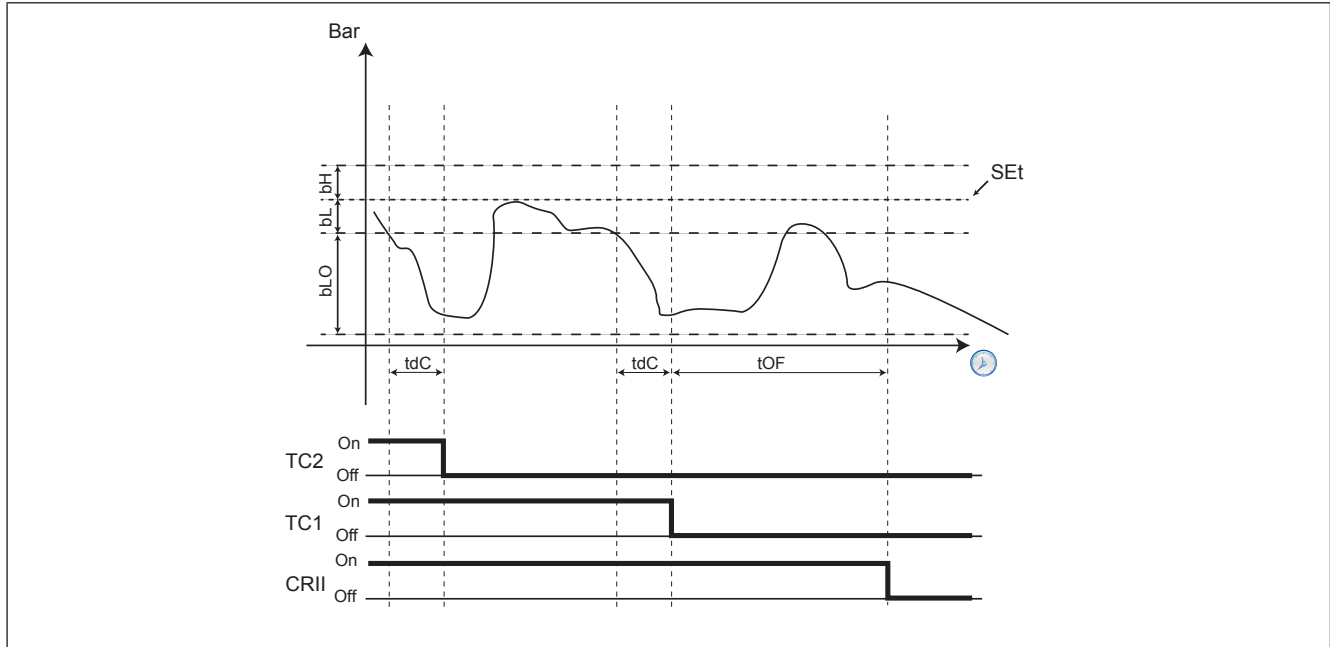

Fig. 35. Switching off the CRII compressor

CHAPTER 9

Fans (FAn)

9.1. Managing the condensation pressure

The **EWCM 436D PRO** controller bases its control on the condensation pressure.

9.1.1. Type of condensation supported

The **EWCM 436D PRO** controller can manage at the same time:

- 2 digital fans;
- Analogue output controlled by PID.

The parameters defining this type of control are:

Parameter	Description
nFn	Number of digital fans
nFA	Number of analogue fans

9.1.2. Supported system configurations

The types of condensation systems that can be used are:

No.	Description	Value par. nFn	Value par. nFA
1	Only one digital output	1	0
2	Two digital outputs	2	0
3	Only one analogue output	0	1
4	One analogue output and one digital output	1	1
5	One analogue output and two digital outputs	2	1

9.1.3. Digital fans

These are controlled by a proportional range positioned on the side compared to the control setpoint.

The range is divided according to the number of fans. If there are 2 fans the proportional range is divided into 2 and at each “step” a fan is switched on (see Fig. 36).

When the condensation pressure is below the SET, all fans are off; when it is above the SET+Band all fans are on. The hysteresis has a delay in both ON (**Fdn**), and OFF (**FdF**).

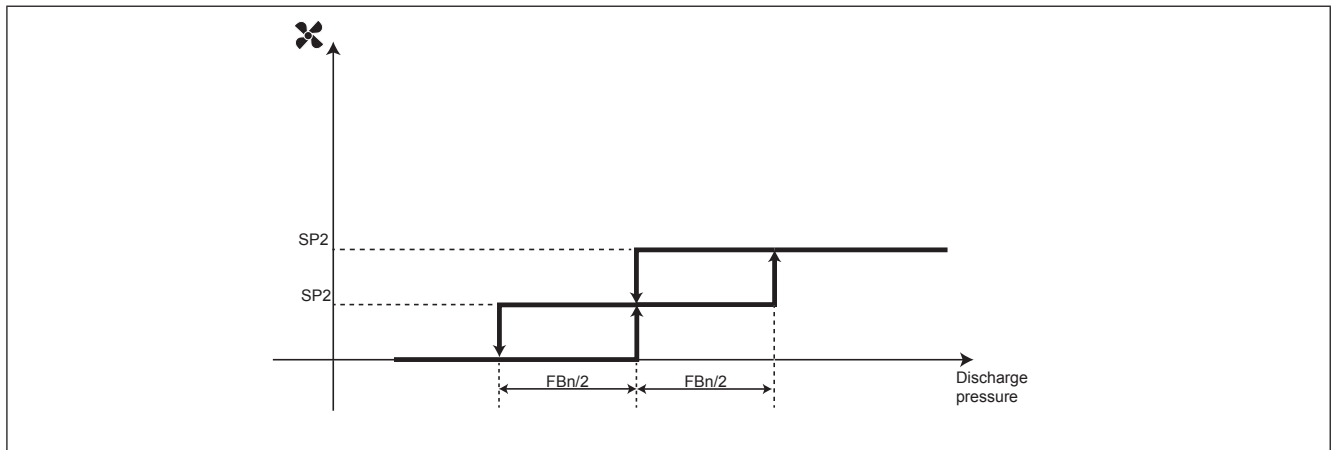

Fig. 36. Enabling the digital fans

9.1.4. Analogue fan

The analogue output managing the condensation is controlled by a PID controller, by default only proportional, with a neutral area of 0.2 Bar.

It is possible to configure a minimum value for the analogue output via the parameter **FLP**. if **FLP** \neq 0 and the output value from the PID is less than **FLP** but more than 0, then the PID is forced to have an output value of **FLP**.

9.2. Floating condensation

9.2.1. Operating conditions

Enabling the function via **EdC** = On.

External temperature is less than the parameter **Het**.

The condensation set-point is calculated by adding the external temperature to the parameter **dtC**.

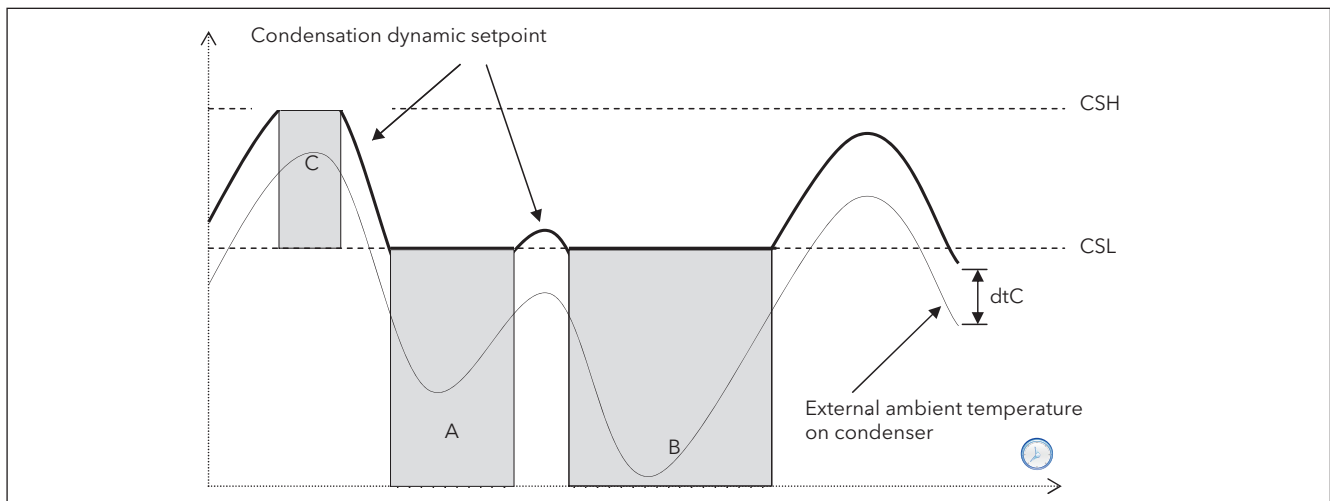

Fig. 37. Floating condensation discharge

9.2.2. Subcooling

Subcooling is used to prevent liquid returns to the condenser and prevent the gas subcooling.

It is enabled by the subcooling probe, Parameter **ELr=On**.

Subcooling **UCtemp** (see Fig. 38) is calculated by using the sub-temperature probe value, positioned upstream of the liquid receiver, and that of the discharge probe

UCtemp = value converted to temperature (discharge gas pressure) – subcooling probe value

In accordance with the second diagram, a further correction is applied to the fluctuating setpoint (summed to the actual setpoint).

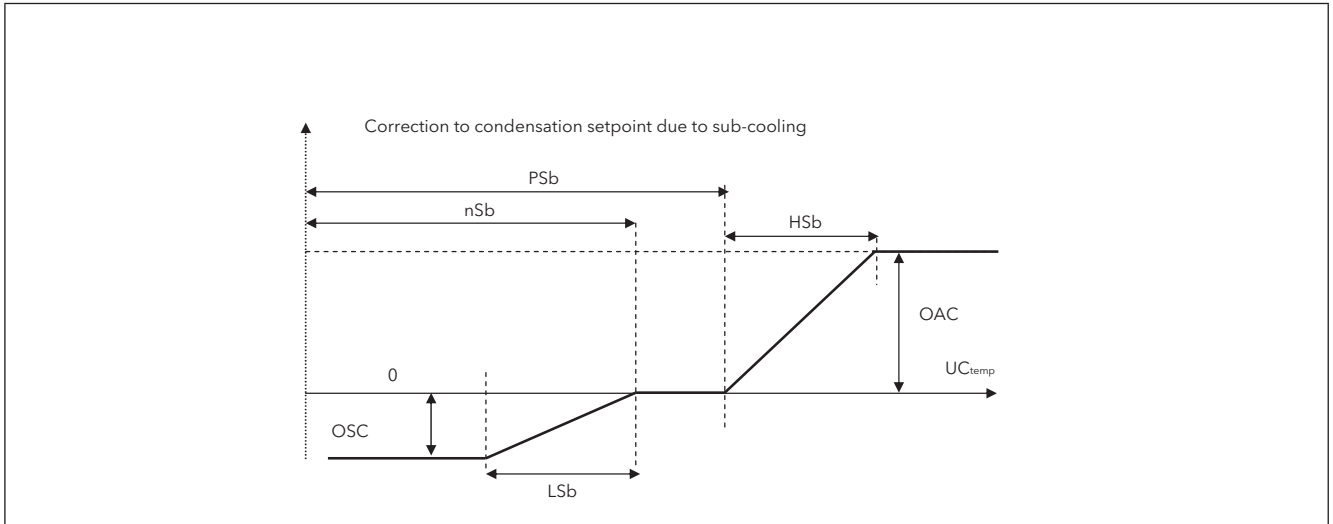

Fig. 38. Floating condensation - Subcooling

Note:

- **nSb** minimum subcooling value;
- **PSb** maximum subcooling value;
- If $nSb < UCtemp < PSb$ no correction;
- For external values-.
 - Proportional correction with deviations $< LSb$ or HSb .
 - Fixed correction deviations greater to or equal to **OSC** or **OAC**.

Having applied the subcooling (where present) there will be the following limitations: The effective value of the floating setpoint will be limited below by **CSL** (areas A and B graph on previous page (See Fig. 37)).

The effective value of the floating setpoint is limited above so that it cannot take on values higher than **CSH** (Area C graph on previous page)

CHAPTER 10

Parameters (PAR)

Parameter setting allows the integral configuration of the **EWCM 436D PRO** controllers.

They can be modified through:

- **MFK 100** and **UNICARD**.
- Keys on front cover or **SKP 10** display.
- Personal computer and **Device Manager** software.

<h3 style="margin: 0;">⚠ WARNING</h3> <p style="margin: 5px 0;">INCORRECT OPERATION OF THE DEVICE</p> <p style="margin: 5px 0;">After editing the BIOS parameters the device must be switched off and on again.</p> <p style="margin: 5px 0;">Failure to follow these instructions can result in death, serious injury, or equipment damage.</p>
--

The following paragraphs provide a detailed analysis of each parameter, divided into categories (folders).

Each folder is designated with a label showing 2 or 3 figures (example: CF, UI, etc.).

Visibility levels (BIOS parameters only)

Four levels of visibility can be set by assigning suitable values to each parameter and folder **serial**, **Device Manager software** or other configuration software) **or via the programming key**.

The visibility levels are:

Value	Visibility level	Need to enter password
3	Parameters or folders always visible	These are always visible even without the password: in this case, the procedure described is not necessary.
2	Manufacturer level These parameters and folders can only be seen by entering the manufacturer's password (see parameter Ui28) (all parameters specified as always visible, parameters that are visible at the installation level, and manufacturer level parameters will be visible)	These (password protected) are visible only when entering the correct password (installation or manufacturer's password) using the following procedure (following table).
1	Installation level These parameters and folders can only be viewed by entering the installation password (see parameter Ui27) (all parameters specified as always visible and parameters that are visible at the installation level will be visible)	
0	Parameter or folders NOT visible	

NOTE: It is possible to manage the visibility of both parameters and folders (See folders table (Folder)).
When modifying the visibility of the folder, the new setting will be valid for all parameters in the folder.

The A-CR11 application parameters are always visible, value 3.

10.1. Parameters / visibility table, folder visibility table and client table

The three **tables below** list all information required to read, write and decode all accessible resources in the device.

Table of parameters	Contains all the configuration parameters for the device saved in the instrument's non-volatile memory, including visibility	See 10.1.1. BIOS parameters / visibility table on page 66
Folders table	Gives the list of visibility of all parameter folders	See 10.1.4. Client Table on page 77 .
Client Table	Includes all I/O and alarm status resources available in the volatile memory of the instrument	See 10.1.4. Client Table on page 77

Description of columns:

FOLDER	Indicates the label of the folder containing the parameter in question.
LABEL	Indicates the label used to display the parameters in the menu of the controller.
VAL PAR ADDRESS	Indicates the address of the modbus register containing the resource to be accessed.
DATA SIZE	Indicates the size of the data in bits. The size is always in WORD = 16 bit.
CPL	When the field indicates "Y", the value read by the register needs to be converted because the value represents a number with a sign. In the other cases the value is always positive or null. To carry out conversion, proceed as follows: <ul style="list-style-type: none"> • If the value in the register is between 0 and 32,767, the result is the value itself (zero and positive values). • If the value in the register is between 32,768 and 65,535, the result is the value of the register – 65,536 (negative values).
EXP	If = -1 the value read by the register is divided by 10 (value/10) to convert it to the values indicated in the RANGE and DEFAULT columns using the unit of measurement in the UM column. Example: parameter CL10 = 50.0. Column EXP = -1: <ul style="list-style-type: none"> • The value read by the device /DeviceManager software is 50.0 • The value read by the register is 500 --> 500/10 = 50.0
VAL PAR ADDRESS	The same as above. In this case, the MODBUS register address contains the visibility value of the parameter. By default all parameters have <ul style="list-style-type: none"> • Data size WORD • Range 0...3 (see Setting a password (Par/PASS folder) on page 44) • U.M. num
VIS PAR VALUE	Indicates the visibility value of the parameter / folder <ul style="list-style-type: none"> • 0 = Never visible. Not visible from the instrument • 1 = Level 1 – see Ui27 • 2 = Level 2 – see Ui28 • 3 = Always visible.
R/W	Indicates the possibility for read and write, read only or write only of the resource: <ul style="list-style-type: none"> • R: the resource is read-only • W: the resource is write-only • RW The resource can be both read and written
RANGE	Describes the interval of values that can be assigned to the parameter. It can be correlated with other parameters in the instrument (indicated with the parameter label). N.B.: if the real value is outside the permitted limits for the parameter (for example, because other parameters defining the limits have been changed), <u>the limit that has been passed</u> and not the real value will be displayed.
DEFAULT	Indicates the factory-set value for the standard version of the instrument.
M.U.	Unit of measurement for values converted according to the rules indicated in the CPL and EXP columns. The unit of measure shown must be considered an example only, as it may change depending on the application (e.g. parameters with a U.M. in °C/bar could also have %RH)

10.1.1. BIOS parameters / visibility table

FOLDER	LABEL	VAL PAR ADDRESS	DATA SIZE	CPL	EXP	VAL PAR ADDRESS	VIS PAR VALUE	R/W	DESCRIPTION	RANGE	DEFAULT	M.U.
CL	CL00	53303	WORD			53584	3	RW	AiL1 analogue input type <ul style="list-style-type: none"> • 0= Probe not configured; • 1= DI; • 2 = NTC; • 3...8 = NOT USED. 	0 ... 8	2	num
CL	CL01	53304	WORD			53585	3	RW	AiL2 analogue input type See CL00	0 ... 8	2	num
CL	CL02	53305	WORD			53586	3	RW	AiL3 type analogue input <ul style="list-style-type: none"> • 0= Probe not configured; • 1= DI; • 2 = NTC; • 3= 4..20 mA; • 4= 0-10 V; • 5= 0-5 V; • 6= 0-1 V; • 7 = 0..20 mA. 	0 ... 7	3	num
CL	CL03	53306	WORD			53587	3	RW	AiL4 analogue input type See CL02	0 ... 7	3	num
CL	CL04	53307	WORD			53588	3	RW	AiL5 analogue input type See CL00	0 ... 8	2	num
CL	CL10	15648	WORD	Y	-1	53589	3	RW	AiL3 analogue input integral scale value	CL11 ... 9999	700	°C/Bar
CL	CL11	15654	WORD	Y	-1	53590	3	RW	AiL3 analogue input start of scale value	-500 ... CL10	-50	°C/Bar
CL	CL12	15649	WORD	Y	-1	53591	3	RW	AiL4 analogue input integral scale value	CL13 ... 9999	300	°C/Bar
CL	CL13	15655	WORD	Y	-1	53592	3	RW	AiL4 analogue input start of scale value	-500 ... CL12	0	°C/Bar
CL	CL20	53333	WORD	Y	-1	53593	3	RW	AiL1 analogue input differential	-120 ... 120	0	°C
CL	CL21	53334	WORD	Y	-1	53594	3	RW	AiL2 analogue input differential	-120 ... 120	0	°C
CL	CL22	53335	WORD	Y	-1	53595	3	RW	AiL3 analogue input differential	-120 ... 120	0	°C/Bar
CL	CL23	53336	WORD	Y	-1	53596	3	RW	AiL4 analogue input differential	-120 ... 120	0	°C/Bar
CL	CL24	53337	WORD	Y	-1	53597	3	RW	AiL5 analogue input differential	-120 ... 120	0	°C

FOLDER	LABEL	VAL PAR ADDRESS	DATA SIZE	CPL	EXP	VAL PAR ADDRESS	VIS PAR VALUE	R/W	DESCRIPTION	RANGE	DEFAULT	M.U.
CF	CF01	53264	WORD			53638	3	RW	<p>Select COM1 protocol Selection of COM1 (TTL) communication channel protocol: 0 = Eliwell; 1 = Modbus Note:</p> <ul style="list-style-type: none"> If CF01=0, parameters CF20/CF21 should be configured. If CF01=1, parameters CF30/CF31/CF32 should be configured. <p>COM1 = TTL/RS485 (cannot be used at the same time)</p>	0 ... 1	1	num
CF	CF20	53271	WORD			53639	3	RW	<p>Eliwell protocol controller address CF20= address of the controller within the family (values valid from 0 to 14) CF21 = device family (values valid from 0 to 14) The two values CF20 and CF21 represent the network address of the device and are indicated in the format "FF.DD" (where FF=CF21 and DD=CF20).</p>	0 ... 14	0	num
CF	CF21	53272	WORD			53640	3	RW	<p>Eliwell protocol controller family See CF21</p>	0 ... 14	0	num
CF	CF30	53273	WORD			53641	3	RW	<p>Modbus protocol controller address Note: 0 (zero) is not included.</p>	1 ... 255	1	num
CF	CF31	53274	WORD			53642	3	RW	<p>Modbus protocol Baudrate</p> <ul style="list-style-type: none"> 0= not used; 1= not used; 2= not used; 3= 9600 baud; 4= 19200 baud; 5= 38400 baud (RS485: not supported); 6= 57600 baud (RS485: not supported); 7= 115200 baud (RS485: not supported). 	0 ... 7	3	num
CF	CF32	53275	WORD			53643	3	RW	<p>Modbus protocol parity</p> <ul style="list-style-type: none"> 1= Even; 2= None; 3= Odd. 	1 ... 3	1	num

FOLDER	LABEL	VAL PAR ADDRESS	DATA SIZE	CPL	EXP	VAL PAR ADDRESS	VIS PAR VALUE	R/W	DESCRIPTION	RANGE	DEFAULT	M.U.
CF	CF60	15638	WORD			53645	3	RW	Client code 1 Parameter for the exclusive use of customers/users. The client can assign these parameters values that e.g. identify the type and/or version of the system, and its configuration etc.	0 ... 999	0	num
CF	CF61	15639	WORD			53646	3	RW	Client code 2 See CF60	0 ... 999	0	num
UI	UI26	15714	WORD			53647	3	RW	Key hold time to enable function	0 ... 999	350	4 ms
UI	UI27	15743	WORD			53648	1	RW	Installer password When enabled (value other than 0), it represents the access password for parameters.	0 ... 255	1	num
UI	UI28	15744	WORD			53649	2	RW	Manufacturer's password When enabled (value other than 0), it represents the access password for parameters.	0 ... 255	2	num

10.1.2. Folder visibility table

LABEL	ADDRESS	R/W	DESCRIPTION	DATA SIZE	RANGE	VIS. PARA. VALUE	M.U.
_VisCarStati_Ai	53519	RW	Folder Ai visibility	WORD	0 ... 3	3	num
_VisCarStati_di	53520	RW	Folder di visibility	WORD	0 ... 3	3	num
_VisCarStati_AO	53521	RW	Folder AO visibility	WORD	0 ... 3	3	num
_VisCarStati_dO	53522	RW	Folder dO visibility	WORD	0 ... 3	3	num
VisCarStati_CL	53523	RW	CL folder visibility	WORD	0 ... 3	3	num
_VisCarProgPar	53524	RW	PAr folder visibility	WORD	0 ... 3	3	num
_VisCarFnC	53525	RW	Folder FnC visibility	WORD	0 ... 3	3	num
_VisCarProgPASS	53526	RW	Folder PASS visibility	WORD	0 ... 3	3	num
_VisCarPrCL	53577	RW	Folder Par\CL visibility	WORD	0 ... 3	3	num
_VisCarPrCF	53580	RW	Folder Par\CF visibility	WORD	0 ... 3	3	num
_VisCarPrUi	53581	RW	Folder Par\Ui visibility	WORD	0 ... 3	3	num
_VisCarCC	53583	RW	Folder Fnc\CC visibility	WORD	0 ... 3	3	num
_VisCarCC\UL	53650	RW	Folder Fnc\CC\UL visibility	WORD	0 ... 3	3	num
_VisCarCC\dL	53651	RW	Folder Fnc\CC\dL visibility	WORD	0 ... 3	3	num
_VisCarCC\Fr	53652	RW	Folder Fnc\CC\Fr visibility	WORD	0 ... 3	3	num

10.1.3. Application parameters table

FOLDER	LABEL	VAL PAR ADDRESS	DATA SIZE	CPL	EXP	VIS PAR VALUE	R/W	DESCRIPTION	RANGE	DEFAULT	M.U.
CnF	Ert	16800	WORD			3	RW	Select type of gas <ul style="list-style-type: none"> • 0=R404A; • 1=R22; • 2=R744; • 3=R290; • 4=R134a; • 5=R407C; • 6=R410A; • 7=R427A; • 8=R507A; • 9=R407A; • 10=R717; • 11=R407F; • 12=R450; • 13-14=R448A; • 15=R513A; • 16=R449A. 	0 ... 16	0	num
CnF	CPn	16801	WORD			3	RW	Number of compressor steps per circuit <ul style="list-style-type: none"> • 0= No compressor • 1= 1 Compressor; • 2= 2 Compressors; • 3= 3 Compressors; • 4= 4 Compressors. 	0 ... 4	1	num
CnF	CPE	16802	WORD			3	RW	Default regulator power value when suction probe error occurs in the suction section <ul style="list-style-type: none"> • 0= No compressor • 1= 1 Compressor; • 2= 2 Compressors; • 3= 3 Compressors; • 4= 4 Compressors. 	0 ... 4	1	num
CnF	nS	16803	WORD			3	RW	Number of solenoid coil CR11 compressors <ul style="list-style-type: none"> • 2= 2 CR11 coils; • 3= 3 CR11 coils. 	2/3	2	num

FOLDER	LABEL	VAL PAR ADDRESS	DATA SIZE	CPL	EXP	VIS PAR VALUE	R/W	DESCRIPTION	RANGE	DEFAULT	M.U.
CnF	nFn	16804	WORD			3	RW	Number of digital fans <ul style="list-style-type: none"> 0= No digital fan; 1= 1 digital fan; 2= 2 digital fans. 	0 ... 2	1	num
CnF	nFA	16805	WORD			3	RW	Number of analogue fans <ul style="list-style-type: none"> 0= No analogue output; 1= 1 fan. 	0/1	1	num
CnF	FtE	16806	WORD			3	RW	Enable discharge probe <ul style="list-style-type: none"> 0= disabled; 1 = enabled. 	0/1	1	Flag
CnF	CtE	16807	WORD			3	RW	Enable suction probe <ul style="list-style-type: none"> 0= disabled; 1 = enabled. 	0/1	0	Flag
CnF	Eet	16808	WORD			3	RW	Enable external temperature probe <ul style="list-style-type: none"> 0= disabled; 1 = enabled. 	0/1	0	Flag
CnF	Elr	16809	WORD			3	RW	Enable subcooling probe <ul style="list-style-type: none"> 0= disabled; 1 = enabled. 	0/1	0	Flag
Ait	01P	16383	WORD			3	RW	Analogue input configurability 1 <ul style="list-style-type: none"> 0= Disabled; 1= External Temperature; 2= Liquid Return Temperature; 3= Discharge temperature; 4= Suction temperature. 	0 ... 4	0	num
Ait	02P	16384	WORD			3	RW	Analogue input configurability 2 As per O1P.	0 ... 4	0	num
Ait	05P	16387	WORD			3	RW	Analogue input configurability 5 As per O1P.	0 ... 4	3	num
AiP	03P	16385	WORD			3	RW	Analogue input configurability 3 <ul style="list-style-type: none"> 0= Disabled; 1= Suction Pressure; 2= Discharge Pressure. 	0 ... 2	1	num
AiP	04P	16386	WORD			3	RW	Analogue input configurability 4 As per O3P.	0 ... 2	2	num

FOLDER	LABEL	VAL PAR ADDRESS	DATA SIZE	CPL	EXP	VIS PAR VALUE	R/W	DESCRIPTION	RANGE	DEFAULT	M.U.
di	i01	16388	WORD	Y		3	RW	Configurability of digital input 1 <ul style="list-style-type: none"> • 0= Disabled; • ±1= CR11 compressor thermal switch; • ±2= Compressor 1 thermal switch; • ±3= Compressor 2 thermal switch; • ±4= Compressor 3 thermal switch; • ±5= Compressor 4 thermal switch; • ±6= Fan thermal switch; • ±7= Maximum pressure switch; • ±8= Minimum pressure switch; • ±9= Remote ON - OFF; • ±10= Enable reduced discharge set; • ±11= Enable reduced suction set. <p>- The "+" sign indicates that the input is active when the contact is closed. - The "-" sign indicates that the input is active when the contact is open.</p>	-11 ... 11	-1	num
di	i02	16389	WORD	Y		3	RW	Configurability of digital input 2 As per i01.	-11 ... 11	-2	num
di	i03	16390	WORD	Y		3	RW	Configurability of digital input 3 As per i01.	-11 ... 11	-6	num
di	i04	16391	WORD	Y		3	RW	Configurability of digital input 4 As per i01.	-11 ... 11	-8	num
di	i05	16392	WORD	Y		3	RW	Configurability of digital input 5 As per i01.	-11 ... 11	-7	num
di	i06	16393	WORD	Y		3	RW	Configurability of digital input 6 As per i01.	-11 ... 11	0	num

FOLDER	LABEL	VAL PAR ADDRESS	DATA SIZE	CPL	EXP	VIS PAR VALUE	R/W	DESCRIPTION	RANGE	DEFAULT	M.U.
AO	03n	16402	WORD	Y		3	RW	Analogue output configurability 3. <ul style="list-style-type: none"> • 0= Disabled; • ±1= CRII compressor drive; • ±2= Alarm Output; • ±3= Compressor 1 drive; • ±4= Compressor 2 drive; • ±5= Compressor 3 drive; • ±6= Compressor 4 drive; • ±7= Digital Fan 1; • ±8= Digital Fan 2; • ±9= Enable Inverter Fan; • 10= Inverter Fan (analogue) <p>- The "+" sign indicates that the output is active when the contact is closed. - The "-" sign indicates that the output is active when the contact is open.</p>	- 9 ... 10	10	num
AO	04n	16403	WORD	Y		3	RW	Analogue output configurability 4. As per 03n.	- 9 ... 10	0	num
AO	05n	16404	WORD			3	RW	Analogue output configurability 5. As per 03n.	0/1	0	num
dO	d01	16394	WORD	Y		3	RW	Configurability of digital output 1. <ul style="list-style-type: none"> • 0= Disabled; • ±1= CRII compressor drive; • ±2= Alarm Output; • ±3= Compressor 1 drive; • ±4= Compressor 2 drive; • ±5= Compressor 3 drive; • ±6= Compressor 4 drive; • ±7= Digital Fan 1; • ±8= Digital Fan 2; • ±9= Enable Inverter Fan; <p>- The "+" sign indicates that the output is active when the contact is closed. - The "-" sign indicates that the output is active when the contact is open.</p>	-9 ... 9	1	num
dO	d02	16395	WORD	Y		3	RW	Configurability of digital output 2. As per d01.	-9 ... 9	3	num
dO	d03	16396	WORD	Y		3	RW	Configurability of digital output 3. As per d01.	-9 ... 9	7	num
dO	d04	16397	WORD	Y		3	RW	Configurability of digital output 4. As per d01.	-9 ... 9	0	num

FOLDER	LABEL	VAL PAR ADDRESS	DATA SIZE	CPL	EXP	VIS PAR VALUE	R/W	DESCRIPTION	RANGE	DEFAULT	M.U.
dO	d05	16398	WORD	Y		3	RW	Configurability of digital output 5. As per d01.	-9 ... 9	0	num
LEd	01u	16524	WORD			3	RW	Configuration of LED 1 <ul style="list-style-type: none"> • 0= Disabled; • 1= CR11 Compressor drive; • 2= Alarm Output; • 3= CR11 capacity 1*; • 4= CR11 capacity 2*; • 5= CR11 capacity 3*; • 6= Compressor 1; • 7= Compressor 2; • 8= Compressor 3; • 9= Compressor 4; • 10= Digital Fan 1; • 11= Digital Fan 2; • 12= Analogue Fan 1. 	0 ... 12	1	num
LEd	02u	16525	WORD			3	RW	Configuration of LED 2. As per 01u.	0 ... 12	3	num
LEd	03u	16526	WORD			3	RW	Configuration of LED 3. As per 01u.	0 ... 12	4	num
LEd	04u	16527	WORD			3	RW	Configuration of LED 4. As per 01u.	0 ... 12	6	num
LEd	05u	16528	WORD			3	RW	Configuration of LED 5. As per 01u.	0 ... 12	10	num
LEd	06u	16529	WORD			3	RW	Configuration of LED 6. As per 01u.	0 ... 12	11	num
LEd	07u	16530	WORD			3	RW	Configuration of LED 7. As per 01u.	0 ... 12	12	num
CPr	SP1	16820	WORD	Y	-2	3	RW	Pressure setpoint in the suction section	0 ... 1000	320	bar
CPr	bHO	16822	WORD	Y	-2	3	RW	Upper band 1 neutral zone	10 ... 500	15	bar
CPr	bH	16821	WORD	Y	-2	3	RW	Upper band 2 neutral zone	10 ... 500	25	bar
CPr	bL	16823	WORD	Y	-2	3	RW	Lower band 1 neutral zone	10 ... 500	15	bar
CPr	bLO	16824	WORD	Y	-2	3	RW	Lower band 2 neutral zone	10 ... 500	25	bar
CPr	dH	16825	WORD			3	RW	Time over upper band 1 for compressor capacity increase	0 ... 600	30	s
CPr	dHO	16826	WORD			3	RW	Time over upper band 2 for compressor capacity increase	0 ... 600	15	s
CPr	dL	16827	WORD			3	RW	Time under lower band 1 for compressor capacity decrease	0 ... 600	10	s
CPr	dLO	16828	WORD			3	RW	Time under lower band 2 for compressor capacity decrease	0 ... 600	5	s
CPr	OS1	16829	WORD	Y	-2	3	RW	Offset on setpoint	-1000 ... 1000	0	bar
CPP	OF1	16830	WORD			3	RW	OFF to ON compressor safety time, suction section 1	0 ... 9999	60	s
CPP	OF2	16831	WORD			3	RW	OFF to ON compressor safety time, suction section 2	0 ... 9999	60	s

FOLDER	LABEL	VAL PAR ADDRESS	DATA SIZE	CPL	EXP	VIS PAR VALUE	R/W	DESCRIPTION	RANGE	DEFAULT	M.U.
CPP	OF3	16832	WORD			3	RW	OFF to ON compressor safety time, suction section 3	0 ... 9999	60	s
CPP	OF4	16833	WORD			3	RW	OFF to ON compressor safety time, suction section 4	0 ... 9999	60	s
CPP	On1	16834	WORD			3	RW	ON to ON compressor safety time, suction section 1	0 ... 9999	60	s
CPP	On2	16835	WORD			3	RW	ON to ON compressor safety time, suction section 2	0 ... 9999	60	s
CPP	On3	16836	WORD			3	RW	ON to ON compressor safety time, suction section 3	0 ... 9999	60	s
CPP	On4	16837	WORD			3	RW	ON to ON compressor safety time, suction section 4	0 ... 9999	60	s
Cr2	tOf	16840	WORD			3	RW	Timeout CRII compressor inactivity before switch off	0 ... 120	60	s
Cr2	CrE	16841	WORD			3	RW	Number of solenoid coil CRII active in case of suction probe error • 0 = No coil connected; • nS = See parameter nS.	0 / nS	1	num
Cr2	tAC	16842	WORD			3	RW	Time over upper band 1 for solenoid coil CRII activation	10 ... 9999	10	s
Cr2	tdC	16843	WORD			3	RW	Time under lower band 1 for solenoid coil CRII deactivation	10 ... 9999	10	s
Cr2	oFC	16844	WORD			3	RW	CRII protection time OFF ON	0 ... 9999	60	s
Cr2	OnC	16845	WORD			3	RW	CRII protection time ON ON	0 ... 9999	60	s
Cr2	OnS	16846	WORD			3	RW	Minimum time solenoid coil CRII ON	5 ... 100	5	s
Cr2	OFS	16847	WORD			3	RW	Minimum time solenoid coil CRII OFF	5 ... 100	5	s
FAn	SP2	16444	WORD	Y	-1	3	RW	Pressure setpoint in the discharge section	0 ... 500	170	bar
FAn	FBn	16445	WORD	Y	-1	3	RW	Proportional pressure band in the discharge section	0 ... 500	20	bar
FAn	Fdn	16446	WORD			3	RW	Fan enabling delay from acknowledgement	0 ... 600	5	s
FAn	FdF	16447	WORD			3	RW	Fans deactivation delay	0 ... 600	5	s
FAn	OS2	16448	WORD	Y	-1	3	RW	Offset on setpoint	-500 ... 500	0	bar
FAi	Ftr	16465	WORD			3	RW	Fans PID sampling time	0 ... 255	10	s/10
FAi	Fti	16466	WORD			3	RW	Fans PID integral time	0 ... 9999	0	s
FAi	Ftd	16467	WORD			3	RW	Fans PID derivative time	0 ... 9999	0	s
FAi	Ftt	16468	WORD			3	RW	Fans PID anti-windup	0 ... 9999	7	s
FAi	FtA	16469	WORD			3	RW	Fans 'PID maximum percentage change per second	0 ... 100	0	%
FAi	FAP	16470	WORD			3	RW	Select PID automatic or manual mode	0/1	1	Flag
FAi	FPE	16472	WORD	Y	-1	3	RW	Fans output percentage in case of probe error	0 ... 1000	1000	%
FAi	FLP	16473	WORD	Y	-1	3	RW	Fans output minimum percentage	0 ... 1000	0	%

FOLDER	LABEL	VAL PAR ADDRESS	DATA SIZE	CPL	EXP	VIS PAR VALUE	R/W	DESCRIPTION	RANGE	DEFAULT	M.U.
FAF	EdC	16454	WORD			3	RW	Selection of dynamic condensation setpoint	0/1	0	Flag
FAF	dtC	16455	WORD	Y	-1	3	RW	Dynamic condensation setpoint temperature offset	0 ... 200	100	°C
FAF	CSH	16456	WORD	Y	-1	3	RW	Floating condensation set-point maximum offset	50 ... 300	170	bar
FAF	CSL	16457	WORD	Y	-1	3	RW	Floating condensation set-point minimum offset	50 ... 300	130	bar
FAF	oAC	16458	WORD	Y	-1	3	RW	Condensation set-point maximum offset	-500 ... 500	100	°C
FAF	oSC	16459	WORD	Y	-1	3	RW	Condensation set-point minimum offset	-500 ... 500	0	°C
FAF	PSb	16460	WORD	Y	-1	3	RW	Sub-cooling setpoint 1 for dynamic condensation setpoint in discharge	-500 ... 500	60	°C
FAF	nSb	16461	WORD	Y	-1	3	RW	Sub-cooling setpoint 2 for dynamic condensation setpoint in discharge	-500 ... 500	30	°C
FAF	HSb	16462	WORD	Y	-1	3	RW	Subcooling maximum band	-500 ... 500	80	°C
FAF	LSb	16463	WORD	Y	-1	3	RW	Subcooling minimum band	-500 ... 500	10	°C
FAF	HEt	16464	WORD	Y	-1	3	RW	Maximum external temperature for floating condensation	0 ... 500	280	°C
ALr	dHA	16849	WORD	Y	-1	3	RW	High pressure alarm activation threshold in discharge	0 ... 300	220	bar
ALr	dHd	16850	WORD	Y	-1	3	RW	High pressure alarm activation delta in discharge	1 ... 10	5	bar
ALr	SLA	16851	WORD	Y	-2	3	RW	Low pressure alarm activation threshold in the suction section	0 ... 800	50	bar
ALr	SLd	16852	WORD	Y	-2	3	RW	Low pressure alarm activation delta in the suction section	1 ... 100	20	bar
ALr	dtA	16853	WORD	Y	-1	3	RW	High temperature alarm activation threshold in discharge	0 ... 1100	1000	°C
ALr	dtd	16854	WORD	Y	-1	3	RW	High temperature alarm activation delta in discharge	1... 500	100	°C
ALr	dtl	16855	WORD			3	RW	Bypass time for high pressure alarm in discharge	0 ... 60	5	min
ALr	OLt	16856	WORD	Y	-1	3	RW	Overheating lower threshold	-1000 ... 1000	20	°C
ALr	OHt	16857	WORD	Y	-1	3	RW	Overheating upper threshold	-1000 ... 1000	120	°C
ALr	Odt	16858	WORD	Y	-1	3	RW	Overheating alarm hysteresis	1 ... 500	20	°C
ALr	OAd	16859	WORD			3	RW	Overheating alarm delay	0 ... 60	5	min
rSt	rC1	16488	WORD			3	RW	Reset Compressor 1 running time	Off/On	/	Flag
rSt	rC2	16495	WORD			3	RW	Reset Compressor 2 running time	Off/On	/	Flag
rSt	rC3	16502	WORD			3	RW	Reset Compressor 3 running time	Off/On	/	Flag
rSt	rC4	16509	WORD			3	RW	Reset Compressor 4 running time	Off/On	/	Flag
rSt	rF1	16516	WORD			3	RW	Reset Fan 1 running time	Off/On	/	Flag
rSt	rF2	16523	WORD			3	RW	Reset Fan 2 running time	Off/On	/	Flag
rSt	rS1	16438	WORD			3	RW	Reset cr2 coil 1 running time	Off/On	/	Flag
rSt	rS2	16439	WORD			3	RW	Reset cr2 coil 2 running time	Off/On	/	Flag

FOLDER	LABEL	VAL PAR ADDRESS	DATA SIZE	CPL	EXP	VIS PAR VALUE	R/W	DESCRIPTION	RANGE	DEFAULT	M.U.
rSt	rS3	16440	WORD			3	RW	Reset cr2 coil 3 running time	Off/On	/	Flag

10.1.4. Client Table

CONTENTS	FOLDER	LABEL	ADDRESS	R/W	DESCRIPTION	DATA SIZE	CPL	RANGE	DEFAULT	EXP	M.U.
1	AI	AI1	9020	R	Suction probe	WORD	Y	-32000 ... 32000		-1	°C
2	AI	AI2	8961	R	Suction probe	WORD	Y	-32000 ... 32000		-2	Bar
3	AI	AI3	9217	R	Discharge probe	WORD	Y	-32000 ... 32000		-1	°C
4	AI	AI4	8962	R	Discharge probe	WORD	Y	-32000 ... 32000		-1	Bar
5	AI	AI5	8963	R	External ambient probe	WORD	Y	-32000 ... 32000		-1	°C
6	AI	AI6	9024	R	Discharge temperature probe	WORD	Y	-32000 ... 32000		-1	°C
7	AI	Tsat	8985	R	Suction temperature probe	WORD	Y	-32000 ... 32000		-1	°C
8	AI	Tliq	8964	R	Liquid return temperature probe	WORD	Y	-32000 ... 32000		-1	°C
9	AI	Tval	8986	R	Valve overheating temperature	WORD	Y	-32000 ... 32000		-1	°C
10	Status	SetA	9018	R	Suction setpoint	WORD	Y	-32000 ... 32000		-2	Bar
11	Status	SetM	9017	R	Discharge setpoint	WORD	Y	-32000 ... 32000		-1	Bar
12	Status	Step1	8973	R	Enable CRII compressor	WORD		0 ... 1			flag
13	Status	Step2	8994	R	Solenoid coil 1 CRII compressor state	WORD		0 ... 1			flag
14	Status	Step3	8995	R	Solenoid coil 2 CRII compressor state	WORD		0 ... 1			flag
15	Status	Step4	8996	R	Solenoid coil 3 CRII compressor state	WORD		0 ... 1			flag
16	Status	StC1	8975	R	Compressor 1 State	WORD		0 ... 1			flag
17	Status	StC2	8976	R	Compressor 2 State	WORD		0 ... 1			flag
18	Status	StC3	8977	R	Compressor 3 State	WORD		0 ... 1			flag
19	Status	StC4	8978	R	Compressor 4 State	WORD		0 ... 1			flag
20	Status	StF1	8979	R	Fan 1 State	WORD		0 ... 1			flag



















CONTENTS	FOLDER	LABEL	ADDRESS	R/W	DESCRIPTION	DATA SIZE	CPL	RANGE	DEFAULT	EXP	M.U.
21	Status	StF2	8980	R	Fan 2 State	WORD		0 ... 1			flag
22	Status	StFi	8981	R	State of compressor piloted by the inverter in the discharge section	WORD		0 ... 1			flag
23	Status	Pfi	9016	R	Power generated by fans piloted by inverter	WORD		0 ... 1000		-1	num
24	Status	Eco	16454	R	Economy in discharge function	WORD		0 ... 1			flag
25	Status	OnOff	8984	R	On	WORD		0 ... 1			flag
26	Status	Alrm	8974	R	Alarm status	WORD		0 ... 1			flag
27	Alarm	Er01	9299	R	Suction pressure input failure	WORD		0 ... 1			flag
28	Alarm	Er02	9300	R	Discharge probe error	WORD		0 ... 1			flag
29	Alarm	Er03	9301	R	External temperature probe error	WORD		0 ... 1			flag
30	Alarm	Er04	9302	R	Liquid return temperature probe error	WORD		0 ... 1			flag
31	Alarm	Er05	9303	R	Discharge temperature probe error	WORD		0 ... 1			flag
32	Alarm	Er06	9304	R	CR11 compressor thermal protection	WORD		0 ... 1			flag
33	Alarm	Er07	9305	R	CR11 compressor high temperature	WORD		0 ... 1			flag
34	Alarm	Er08	9306	R	High pressure switch alarm	WORD		0 ... 1			flag
35	Alarm	Er09	9307	R	Low pressure switch alarm	WORD		0 ... 1			flag
36	Alarm	Er10	9308	R	Compressor 1 thermal switch alarm	WORD		0 ... 1			flag
37	Alarm	Er11	9309	R	Compressor 2 thermal switch alarm	WORD		0 ... 1			flag
38	Alarm	Er12	9310	R	Compressor 3 thermal switch alarm	WORD		0 ... 1			flag
39	Alarm	Er13	9311	R	Compressor 4 thermal switch alarm	WORD		0 ... 1			flag
40	Alarm	Er14	9312	R	Fan thermal switch alarm	WORD		0 ... 1			flag
41	Alarm	Er15	9313	R	Suction section low pressure	WORD		0 ... 1			flag
42	Alarm	Er16	9314	R	High pressure condensation alarm	WORD		0 ... 1			flag
43	Alarm	Er17	9315	R	Suction temperature input failure	WORD		0 ... 1			flag
44	Alarm	Er18	9316	R	Low overheating alarm	WORD		0 ... 1			flag
45	Alarm	Er19	9317	R	High overheating alarm	WORD		0 ... 1			flag
46	Command	nSB	16408	R	Instrument On	WORD		0 ... 1			flag
47	Command	oSB	16408	R	Instrument Off	WORD		0 ... 1			flag
48	Command	rC1	16488	R	Reset compressor 1 running time	WORD		0 ... 1			flag
49	Command	rC2	16495	R	Reset compressor 2 running time	WORD		0 ... 1			flag
50	Command	rC3	16502	R	Reset compressor 3 running time	WORD		0 ... 1			flag

CONTENTS	FOLDER	LABEL	ADDRESS	R/W	DESCRIPTION	DATA SIZE	CPL	RANGE	DEFAULT	EXP	M.U.
51	Command	rC4	16509	R	Reset compressor 4 running time	WORD		0 ... 1			flag
52	Command	rS1	16438	R	Reset CR11 compressor coil 1 running time	WORD		0 ... 1			flag
53	Command	rS2	16439	R	Reset CR11 compressor coil running hours 2	WORD		0 ... 1			flag
54	Command	rS3	16440	R	Reset CR11 compressor coil 3 running time	WORD		0 ... 1			flag
55	Command	rF1	16516	R	Reset fan 1 running time	WORD		0 ... 1			flag
56	Command	rF2	16523		Reset fan 2 running time	WORD		0 ... 1			flag

CHAPTER 11

Alarms

The description of the alarms and how to solve the problem is given below:

Label	Description	Reset	Action	Problem solving
Er01	Suction pressure probe error (see para. CPE and CRE)	AUTO	  Block	<ul style="list-style-type: none"> • Check wiring • Replace probe • Wait for the read temperature value to come back
Er02	Discharge pressure probe error	AUTO	  Block  100% ON	<ul style="list-style-type: none"> • Check wiring • Replace probe • Wait for the read temperature value to come back
Er03	External temperature probe error	AUTO	Floating condensation Block	<ul style="list-style-type: none"> • Check wiring • Replace probe • Wait for the read temperature value to come back
Er04	Liquid return temperature probe error	AUTO	Sub-cooling Block	<ul style="list-style-type: none"> • Check wiring • Replace probe • Wait for the read temperature value to come back
Er05	External temperature probe discharge error	AUTO	 Block	<ul style="list-style-type: none"> • Check wiring • Replace probe • Wait for the read temperature value to come back
Er06	CRII compressor thermal switch	AUTO	 Block	Check the relative digital input (D.I.1)
Er07	CRII compressor high temperature	AUTO + dtt	 Block	Wait for the discharge temperature to return to within the nominal values
Er08	Maximum pressure switch alarm	AUTO	 100% ON	Wait for the discharge pressure to return to within the nominal values.
Er09	Minimum pressure switch alarm	AUTO	  Block	Wait for the discharge pressure to return to within the nominal values.
Er10	Compressor 1 thermal switch alarm	AUTO	 Block	Check the relative digital input (D.I.2)
Er11	Compressor 2 thermal switch alarm	AUTO	 Block	Check the relative digital input
Er12	Compressor 3 thermal switch alarm	AUTO	 Block	Check the relative digital input
Er13	Compressor 4 thermal switch alarm	AUTO	 Block	Check the relative digital input
Er14	Fans thermal switch alarm	AUTO	   Block	Check the relative digital input (D.I.3)
Er15	Low suction pressure alarm	AUTO	Display only	---
Er16	High pressure condensation alarm	AUTO	Display only	---
Er17	Suction temperature probe error	AUTO	Display only	<ul style="list-style-type: none"> • Check wiring • Replace probe • Wait for the read temperature value to come back
Er18	Low overheating alarm	AUTO	Display only	---
Er19	High overheating alarm	AUTO	Display only	---

11.1. Alarm log

When an error or alarm occurs it is stored with the date and time.

The controller stores the last 20 alarms in its memory.

To view the log enter the Set menu, then the folder **Hyst**.

There are 4 memory positions in this folder:

- **HySP** indicates the position in the alarm log;
- **HySC** indicates the alarm code;
- **HySd** indicates the alarm date;
- **HySt** indicates the alarm time.
- **HiSF** indicates the number of alarms stored.

The user chooses the memory position by setting a value from 0 to 19 (**HySP**) and can then view the other variables.

The Alarm/Error codes go from 1 to 19 in the order shown in [CHAPTER 11 on page 80](#).

Press UP (F1) in the main screen for a few seconds to reset the alarm log.

CHAPTER 12

Updating the device

12.1. Direct connection with Device Manager

Use **DMI 100-3** to connect the **EWCM 436D PRO** controller (target) to the PC/serial port for quick parameter programming.

Connecting the DMI 100-3

To connect the **DMI 100-3** to the **EWCM 436D PRO** use the **YELLOW (YW)** cable.

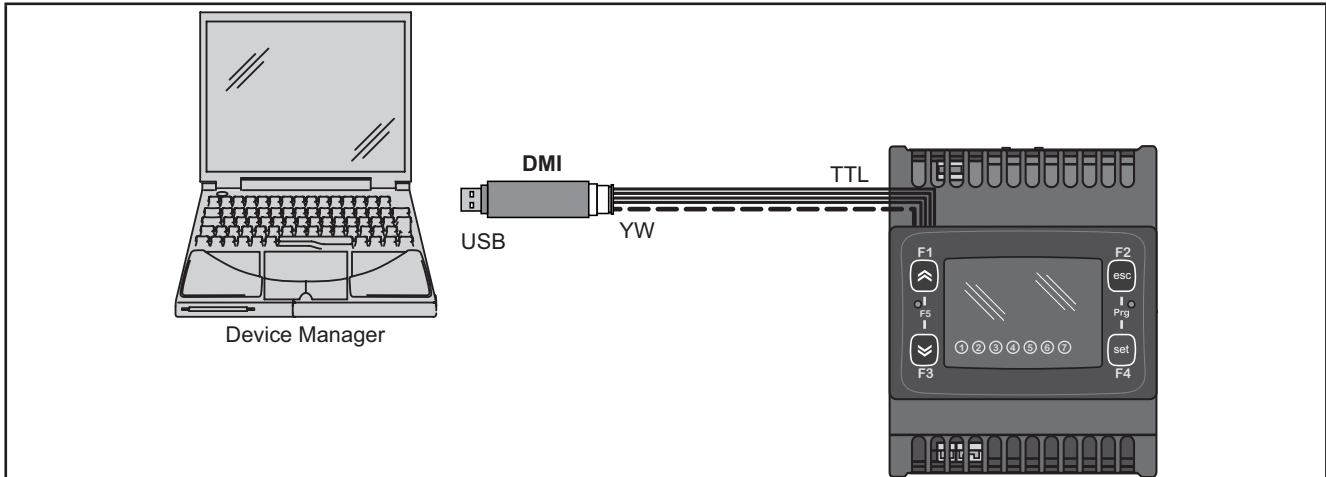

Fig. 39. Connection between **DMI 100-3 / UNICARD** and **EWCM 436D PRO**

NOTE: in "Direct" mode, **EWCM 436D PRO** must not be connected to earth. When connecting to earth (ground) for both the PC and the **EWCM 436D PRO** there could be a ring ground condition that makes both the PC and the **EWCM 436D PRO** unusable.

NOTICE

INOPERABLE DEVICE

Disconnect all earth connections on the device before connecting to a PC.

Failure to follow these instructions can result in equipment damage.

12.2. Connecting to UNICARD / MFK 100

To connect the **MFK 100** to the **DMI 100-3** use the **BLUE** cable.

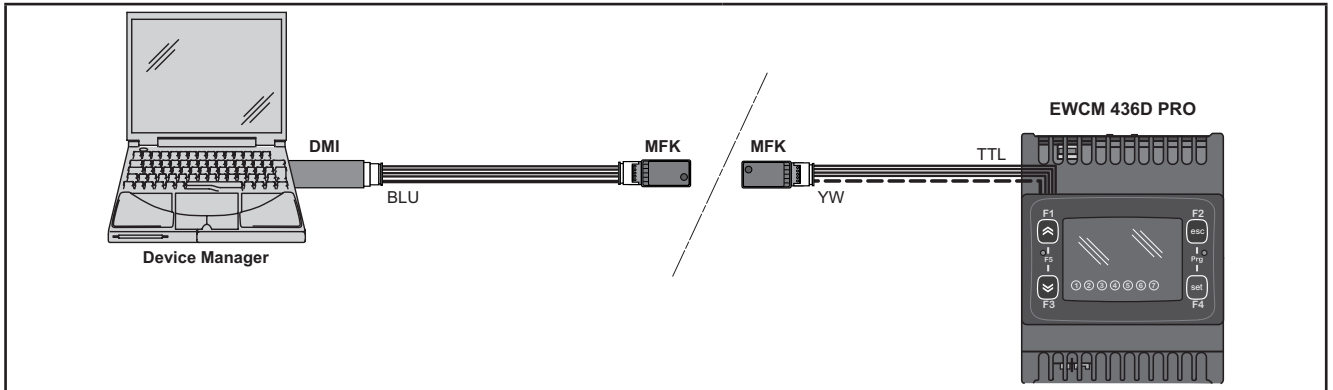

Fig. 40. Connection between the MFK 100/UNICARD and DMI 100-3 + Device Manager

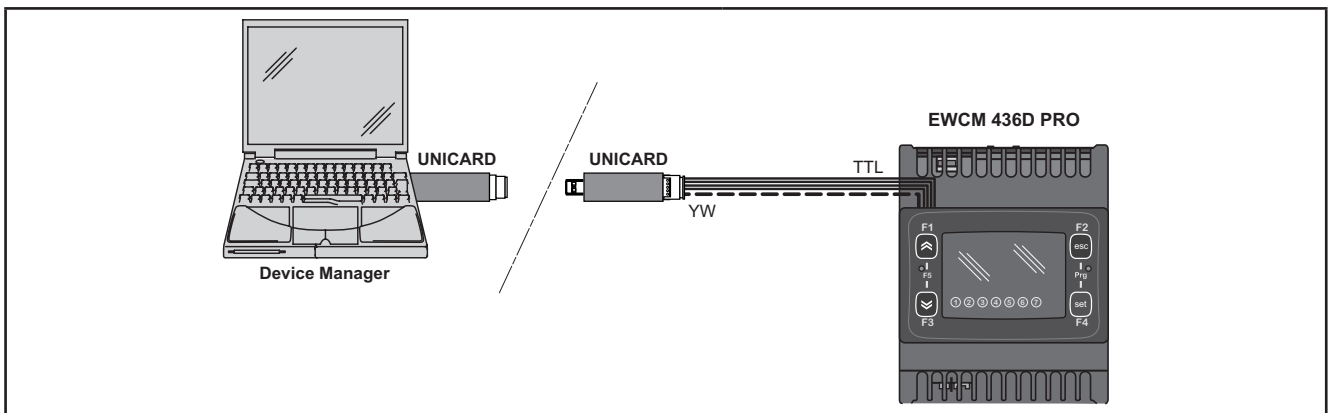

Fig. 41. Connections between UNICARD and Device Manager + **EWCM 436D PRO**

Device Manager → MFK 100 / UNICARD	Device Manager ← MFK 100 / UNICARD
Parameters	Parameters
Fw	-

⚠ WARNING

INCORRECT OPERATION OF THE DEVICE

- Connect the programming cable firstly to the PC and then to the controller programming port.
- Disconnect the programming cable from the controller before disconnecting from the PC.

Failure to follow these instructions can result in death, serious injury, or equipment damage.

12.3. Firmware updating

To update the firmware on the **EWCM 436D PRO** controller first update the UNICARD key/MFK 100 using **Device Manager**. Connecting to the **EWCM 436D PRO** controller having switched off the updated key, the firmware download will run automatically when the instrument is switched on. The key led flashes while the operation is in progress.

When completed, the key led may be in one of the following statuses:

- ON: If the operation was successful.
- OFF: If the operation was not successful (in this case repeat the procedure or update the key contents).

NOTE: When connecting a key with the same contents as the controller, no firmware will be downloaded and the key led will stay off.

CHAPTER 13

Monitoring

The serial TTL - also called COM1 – can be used to configure the device, parameters, states, and variables via the Modbus protocol.

13.1. Configuration with Modbus RTU

Modbus is a client/server protocol for communication between devices connected in a network.

Modbus devices communicate using a master-slave technique in which only one device (master) can send messages. The other devices in the network (slave) respond, returning the data requested by the master or executing the action contained in the message received. A slave is a device connected to a network that processes information and sends the results to the master using the ModBUS protocol.

The master device can send messages to individual slaves or to the entire network (broadcast) whilst slaves can only respond individually sent by the master.

NOTE: The Modbus standard used by **Eliwell** employs the RTU code for data transmission.

13.1.1. Data format (RTU)

The coding model used defines the structure of messages transmitted on the network and the way in which this information is deciphered. The coding type is usually chosen according to specific parameters (baud rate, parity, etc.)*** and some devices only support certain coding models. However, the model use must be the same as those used for all devices, connected to a Modbus network.

The protocol used adopts the RTU binary method with bytes configured as follows:
8 bit for data, even parity bit (not configurable), 1 stop bit.

***configured with parameters **CF30**, **CF31**.

Parameter setting allows the integral configuration of the device.
They can be modified through:

- Device keypad.
- **MFK 100**.
- Sending data via Modbus protocol directly to an individual controller or broadcasting it using the address 0 (broadcast).

For the connection diagram using Modbus see **Fig. 13 on page 24**.

Device / Bus Adapter connection	TTL 5-way connector cable (30cm) (additional lengths/sizes available)
Bus Adapter	BA150
Bus Adapter / Interface connection	RS485 cable screened and twisted (e.g.: Belden cable model 8762).

13.1.2. Modbus commands available and data areas

The following commands are implemented:

Modbus command	Description of command
3	Reading more than one log on the Client side
6	Writing only one log on the Client side
16	Writing on more than one lo on the Client side
43	Read device ID
	DESCRIPTION Manufacturer ID Model ID Version ID

The length limits are:

Maximum length in bytes of messages sent to device	30 BYTE
Maximum length in bytes of messages received from the device	30 BYTE

NOTE: For the variables see [10.1.4. Client Table on page 77](#).

13.2. Configuration of device address

The address of a device (Device Number) in a ModBus message is defined in parameter **CF30** (see [10.1.1. BIOS parameters / visibility table on page 66](#)).

The address 0 is used for broadcast messages that all slaves recognize.

NOTE: The slaves do not respond to broadcast messages.

13.2.1. Configuration of parameter addresses

The list of addresses is given in [CHAPTER 10 Parameters \(PAR\) on page 64](#), under "Parameters/Visibility Table / ADDRESS column (parameters addresses) and VIS PAR ADDRESS (addresses visibility parameters).

13.2.2. Configuration of variable addresses / states

The address list is provided in the [CHAPTER 10 Parameters \(PAR\) on page 64](#), Client Table section, ADDRESS column.



by **Schneider** Electric

Eliwell Controls s.r.l.

Via dell'Industria, 15 • Z.I. Paludi
32010 Pieve d'Alpago (BL) ITALY

Telephone +39 0437 986 111

www.eliwell.com

Customer's Technical Support

Telephone +39 0437 986 300

E techsuppeliwell@schneider-electric.com

Sales office

Telephone +39 0437 986 100 (Italy)

Telephone +39 0437 986 200 (other countries)

E saleseliwell@schneider-electric.com

